

---

# Cloud connected sensor XIOT range

## Catalogue



Simply easy!™



# Cloud connected sensor XIOT range

For remote device monitoring

---

■ <b>Cloud connected switch</b>	
□ General presentation . . . . .	page 2
□ References . . . . .	page 3
□ Functions . . . . .	page 4
□ Presentation of the transmitter . . . . .	page 5
□ Characteristics of the transmitter . . . . .	page 6
□ Dimensions of the transmitter . . . . .	page 7
□ Connections of the transmitter . . . . .	page 7
■ <b>Product reference index</b> . . . . .	page 8

### Cloud connected switch XIOT range

The Internet of Things (IoT) is the extension of the Internet to connected devices. Telemecanique Sensors offers a wireless solution to collect data from remote equipment and use this data, via the Internet, on a PC or mobile device.

The XIOT Cloud connected switch from Telemecanique Sensors is based on LPWAN (low power wide area network) technology, operated by Sigfox.

The Sigfox network covers 32 countries and is already very extensive in Europe. It is also being rapidly deployed in the US and Asia-Pacific. It uses antennas with a range of around 50 km.

The map on the Sigfox website shows exactly which areas are covered by the network (see <https://sigfox.com/en/coverage>).

When the contacts on a switch installed on your site change state **1**, the transmitter **2** sends a message to the IoT network (LPWAN) **3**, which is then routed to our secure servers **4**.

This message is then delivered to one or more recipients as an alert on PC, tablet, or smartphone **5**.



XIOT Cloud connected sensor  
Click to view video (1 min 36 s)



### For areas without electricity or difficult-to-access areas

The XIOT Cloud connected switch is used to signal a significant or abnormal change of state on your devices.

> **Agricultural applications**

- > Irrigation systems (pressure threshold monitoring)
- > Buildings and hoisting equipment (hatch and door positions)
- > HVAC

> **Water treatment applications** (pumping, tank monitoring)

- > Water treatment plants
- > Valves
- > Flood gates

> **Mining and quarrying applications** (Emergency stop monitoring)

- > Conveyors

\* EcoStruxure™ is Schneider Electric's IoT platform.

# Cloud connected switch

## XIOT range

For remote device monitoring



### Real-time alerts via the Cloud

The XIOT Cloud connected switch gives you precise, reliable data about your installations in real time.

You can configure this data to suit your requirements for:

- > Operation
- > Receiving alerts
- > Event history, etc.

The information can be received by one or more recipients on a PC, tablet, or smartphone in the form of e-mails and notifications.

Connections are also offered for integrating data in SCADA (supervisory control and data acquisition) systems.

### Reduce operational downtime

- > Optimized production
- > Direct alert delivered to the relevant recipients
- > Easy diagnostics

### Prevent and reduce maintenance

- > For greater machine availability
- > For greater process reliability



### 3 options to choose from

Description	Transmitter only	Prepaid 5-year access to Cloud	Subscription services (1)
	XIOT11SE0MRCL	XIOT11SE5MRCL	XIOT11SERMRCL
> 1 standalone transmitter	☑	☑	☑
> Activation magnet			
> Instruction sheet			
> 5-year subscription to Sigfox LPWAN (2)	—	☑	—
> Web interface to configure and display data	—	☑	☑
> Smartphone apps for alert notifications (iOS and Android)	—	☑	☑
> Connection to Telemecanique Sensors secure servers via external SCADA system for data processing	—	—	☑

### References

Description	Reference	Weight kg
Transmitter only	XIOT11SE0MRCL	0.216
Prepaid 5-year access to Cloud	XIOT11SE5MRCL	—
Subscription services	XIOT11SERMRCL	—

(1) Pricing and terms and conditions available on the online payment site:

<https://godigital.schneider-electric.com/smp/home/home.page>

(2) LPWAN: Low power wide area network

# Cloud connected switch

## XIOT range

For remote device monitoring

### Operating tools

#### Configuration/Access to user data from a web browser (<https://xiot.tesensors.com>)

- > Creation of a password-protected user account
- > Enrollment and configuration of transmitters linked to the account:
- > Configuration of alerts:
  - Opening and/or closing of contacts connected to the transmitter
  - Discharge of internal battery
  - Abnormal frequency of transmission
  - Type (e-mail, notification on smartphone)
  - Recipient(s)
- > Geographical location of transmitter (manual entry)

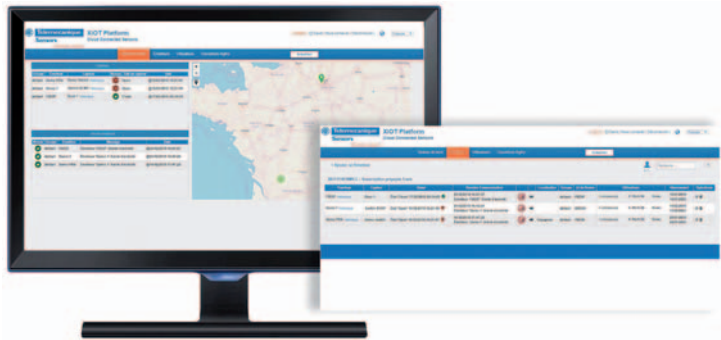

#### Operation

- > State of each contact connected to each transmitter
- > History of events transmitted by each transmitter
- > Quality of signal received from each transmitter
- > Online purchase of services at <https://godigital.schneider-electric.com/smp/home/home.page> (for XIOT11SE0MRCL reference only)



#### Dedicated smartphone app

- > Available for iOS and Android, this app can be used to receive alert notifications from transmitters (requires Internet access).
- > The app can also be used to display the state of all transmitters linked to the user account and to enroll a transmitter to an account by scanning its QR code.

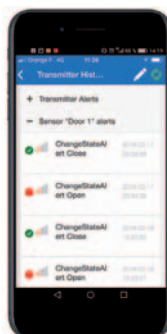

# Standalone transmitter connected via LPWAN radio link <sup>(1)</sup>

XIOT range

For remote device monitoring

IP66 transmitter for indoor or outdoor applications (-25 °C to +70 °C)

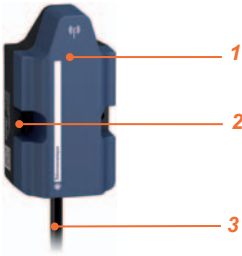

- 1: PBT case
- 2: 2 holes for screw mounting
- 3: 2 m PVC cable for connection to the switch

## Rugged standalone transmitter

### Up to 10 years of standalone operation

- > Powered by built-in Lithium battery with a lifespan of over 5 years (up to 10 years for 2 frames/day)
- > IP 66 protection provided by a sealed case with one cable outlet (PVC, 4-wire, for connecting 2 volt-free contacts)
- > Transmitter can be enrolled from a smartphone app or via a web page
- > Supplied with external magnet for activation purposes
- > Screw mounting

## A complete offer of associated switches <sup>(2)</sup>

### XM pressure switches

- > Electromechanical pressure and vacuum switches for control circuits
- > Fluids detected: air, fresh water, sea water, hydraulic oils, corrosive fluids, and viscous fluids

### XC limit switches

- > Metal or plastic limit switches, miniature or standard format, industrial EN 50041 format, compact CENELEC EN 50047 format, etc.
- > Dedicated limit switches for hoisting, material handling, and conveyor belt shift monitoring applications



**NB:** The XIOT Cloud connected switches are operated on radio networks which can be perturbed by external sources. In addition, a permanent access to data and services through internet is dependent to third party operators and cannot be ensured at 100%. Therefore, the system must not be used for critical alerts.

(1) LPWAN: Low power wide area network

(2) Please consult our website [www.tesensors.com](http://www.tesensors.com).



# Standalone transmitter connected via LPWAN radio link <sup>(1)</sup>

XIOT range

For remote device monitoring

Electrical characteristics			
		Transmitter	
Power supply	Type		Built-in Lithium battery
	Voltage	V	3.6
	Battery life		13.6 years for 2 frames/day 4.2 years for 10 frames/day 2.3 years for 20 frames/day
Inputs	Type		2 low-level inputs (3 V/6 μA), volt-free contacts
	Filtering		100 ms
	Detection level		State 1 > 1.7 V State 0 > 0.7 V
Compatibility	With limit switches		XCM, XCKM, XCKL, XCKS, XCKJ, XCKN, XCKP, XCKT, XCKD, and XCRT <sup>(2)</sup>
	With pressure switches		XMLA, XMLB, XMLC, and XMLD <sup>(2)</sup>
Mechanical characteristics			
Connection			Via 2 m PVC cable Number of wires and cross sectional area: 4 x 0.34 mm <sup>2</sup> /AWG 22
Materials			PBT and PA case
Mounting			Screws (2 x 4 mm) Maximum tightening torque: 3 Nm/26.6 lb-in
Dimensions (W x H x D)		mm	50 x 100 x 45
		in.	1.96 x 3.94 x 1.77
Weight			0.216 kg/0.478 lb
Radio characteristics			
Power			14 dBm (25 mW)
Frequency	Europe		868 MHz
Range			Up to 10 km
Network coverage			See the map on the following website: <a href="https://sigfox.com/en/coverage">https://sigfox.com/en/coverage</a> The XIOT smartphone app also offers a network coverage checker to find out the signal strength: <a href="https://xiot.tesensors.com">https://xiot.tesensors.com</a>
Transmission	Sending		On change of state of inputs + 1 status frame per day
	Frame transmission frequency		6/hour and 50/day maximum (1 frame for each change of state of one of the inputs)
	Frames		Sigfox format: 12 bytes, 100 bps
	Reception		No
	Activation		By external magnet supplied with the transmitter
Environment characteristics			
Product certifications			CE, Sigfox ready
Radio standards			EN 62368-1, EN 300-220, EN 301-489
Ambient temperature	For operation	°C	-25...+70 Do not exceed +65 °C and 85% relative humidity in permanent exposure conditions outdoors
Degree of protection			IP 66

<sup>(1)</sup> LPWAN: Low power wide area network

<sup>(2)</sup> Please consult our website: [www.tesensors.com](http://www.tesensors.com).



## Dimensions

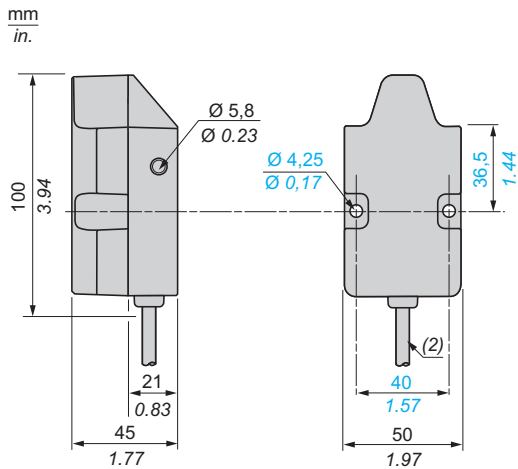

## Connections

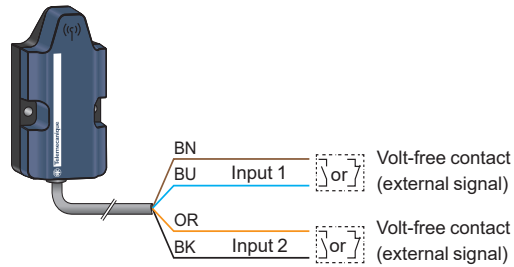

BN: Brown  
BU: Blue  
OR: Orange  
BK: Black

## Mounting precautions

### Flat surface mounting

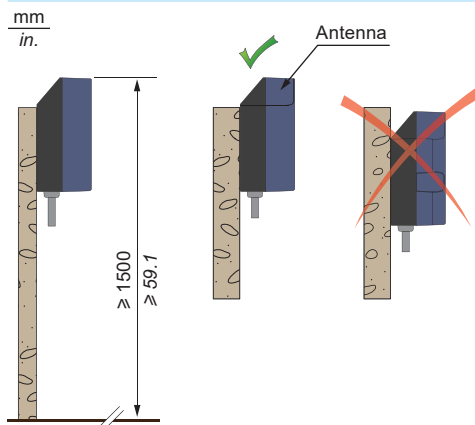

### Free area

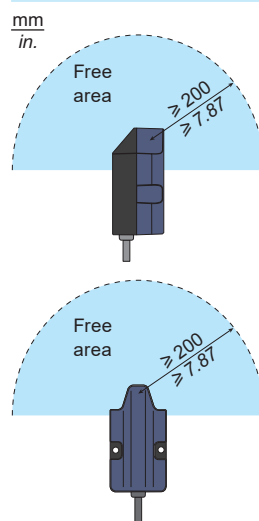

### Mounting in a metal cabinet

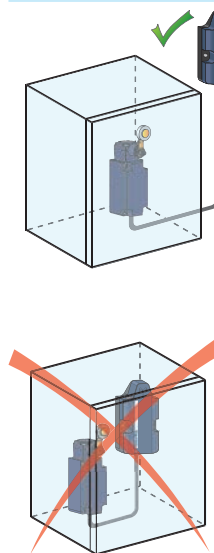

## Signal attenuation according to the material

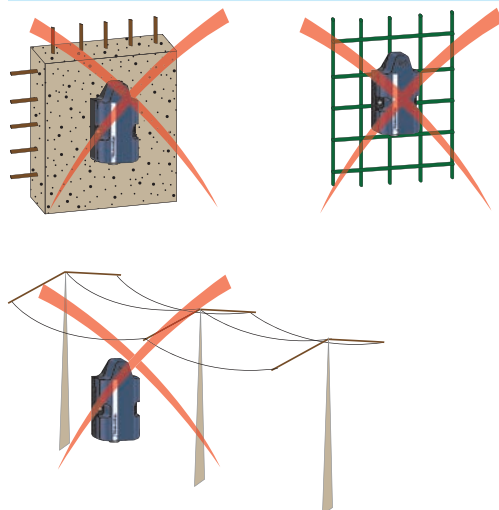

Material	Signal attenuation <sup>(3)</sup> %	Material attenuation db
Glass window	10...20	2
Plaster wall	20...30	3
Brick wall	50	6
Concrete wall	70...80	15
Metal structure	70...100	30
High voltage grid	50...90	20

<sup>(1)</sup> LPWAN: Low Power Wide Area Network

<sup>(2)</sup> 2 m/6.6 ft cable

<sup>(3)</sup> Values for indication purposes only. Actual values depend on the thickness and nature of the material

**NB:** If you wish to extend the cable to an overall length of more than 3 meters, you need to take the necessary installation precautions if there is any electrical equipment nearby. Keep the cable away from any equipment generating electromagnetic interference, such as transformers, power supply lines, electrical welding equipment, etc.

<b>X</b>	
XIOT11SE0MRCL	3
XIOT11SE5MRCL	3
XIOT11SERMRCL	3



**Schneider Electric Industries SAS**

Head Office  
35, rue Joseph Monier  
F-92500 Rueil-Malmaison  
France

[www.tesensors.com](http://www.tesensors.com)

The information provided in this documentation contains general descriptions and/or technical characteristics of the performance of the products contained herein. This documentation is not intended as a substitute for and is not to be used for determining suitability or reliability of these products for specific user applications. It is the duty of any such user or integrator to perform the appropriate and complete risk analysis, evaluation and testing of the products with respect to the relevant specific application or use thereof. Neither Schneider Electric nor any of its affiliates or subsidiaries shall be responsible or liable for misuse of the information contained herein.

Design: Schneider Electric  
Photos: Schneider Electric

September 2018 - V3.0

DIA4ED2180304EN