

FACTORY AUTOMATION

Mitsubishi Electric Sensorless Servo

Global PM Motors EM-A Series

Expanded Lineup of 3.7 kW to 7.5 kW

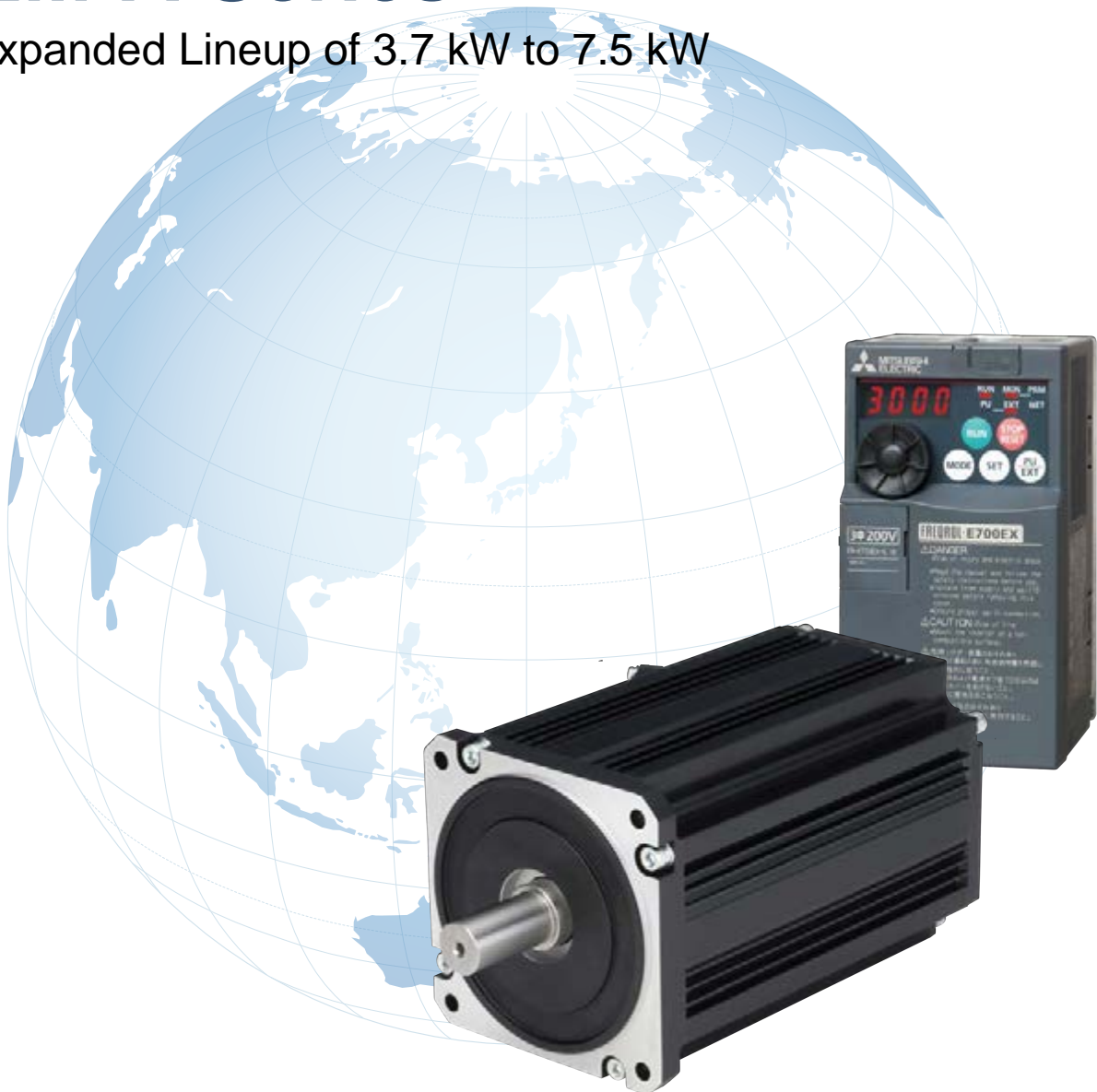

GLOBAL IMPACT OF MITSUBISHI ELECTRIC



Through Mitsubishi Electric's vision, "Changes for the Better" are possible for a brighter future.

Changes for the Better

"Changes for the Better" represents the Mitsubishi Electric Group's attitude to "always strive to achieve something better", as we continue to change and grow. Each one of us shares a strong will and passion to continuously aim for change, reinforcing our commitment to creating "an even better tomorrow".

Mitsubishi Electric is involved in many areas including the following:

Energy and Electric Systems

A wide range of power and electrical products from generators to large-scale displays.

Electronic Devices

A wide portfolio of cutting-edge semiconductor devices for systems and products.

Home Appliance

Dependable consumer products like air conditioners and home entertainment systems.

Information and Communication Systems

Commercial and consumer-centric equipment, products and systems.

Industrial Automation Systems

Maximizing productivity and efficiency with cutting-edge automation technology.

Our advances in AI and IoT are adding new value to society in diverse areas from automation to information systems. The creation of game-changing solutions is helping to transform the world, which is why we are honored to be recognized in the 2019 "Forbes Digital 100" as one of world's most influential digital corporations.



Mitsubishi Sensorless Servo Global PM Motors

EM-Aseries

For EM-A Series, Mitsubishi has developed a unique salient-pole core* to realize high-performance magnetic motors that can ensure positioning and speed control without a sensor.

*Patent No.: 5646119

Downsizing and energy saving

Globalization

High performance



Downsizing and energy saving

Problems

- Downsizing of equipment
- Energy saving

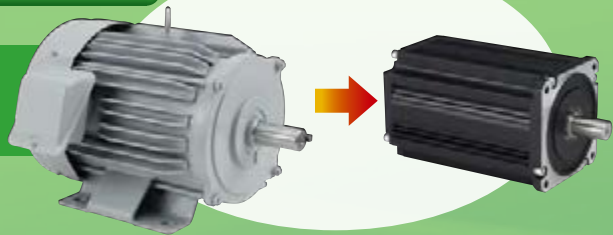

Solutions

- The motors use cores with optimum shapes for sensorless control, and the motor frame numbers are lower by 1 or 2 compared to induction motors. Then, the equipment can be downsized.
- The use of the magnetic motors meeting the efficiency class* IE5 for variable speed motors can promote energy saving.

* According to the efficiency reference values (%) for variable speed motors (rated speed 1801 to 6000 r/min) based on IEC60034-30-2.

Globalization

Problems

- Use of the same motor in the equipment exported to various countries

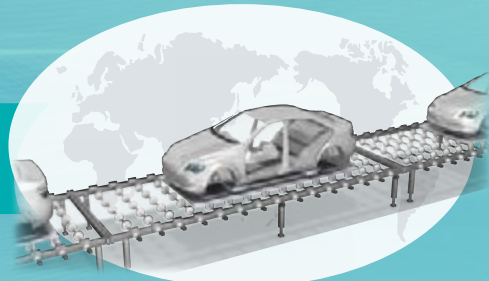

Solutions

- Since the magnetic motors do not require*1 the high efficiency certification in each country, they can be easily used in the equipment to be exported.
- Overseas safety standard certification has been acquired. (UL, CE)*2

*1: Information as of April 2021 (Energy efficiency label is required for China.)

*2: Acquisition for 3.7 to 7.5 kW is planned.

High performance

Problems

- Improvement of equipment performance and cost reduction

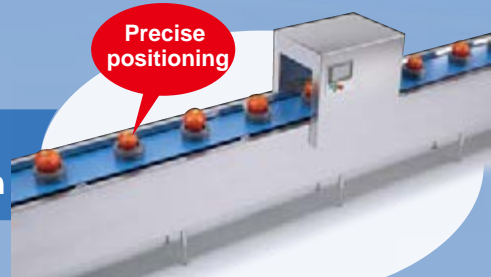

Solutions

- Mitsubishi's unique sensorless control realizes precise speed control comparable to that by servo motors.
- Positioning control can be achieved without a sensor (encoder).

Downsizing and energy saving

Downsizing

- The motor core shape optimum for sensorless control realizes 50 to 60% reduction of volume and 30 to 50% reduction of mass compared to induction motors.

[Comparison of volume]

Induction motor (SF-PRF, 2P, 0.75 kW)

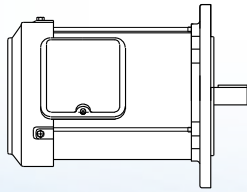

Volume ratio reduced by about **50%**



EM-AMF, 0.75 kW

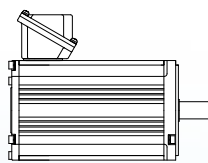

[Volume] When the volume of induction motors is 1

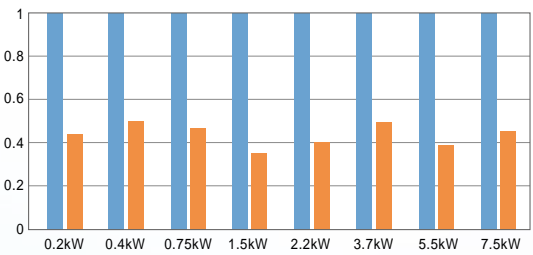

Reduction of about **50% to 60%**

[Comparison of mass]

Induction motor (SF-PRF, 2P, 0.75 kW)

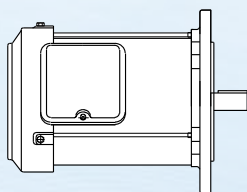

Mass ratio reduced by about **50%**



EM-AMF, 0.75 kW

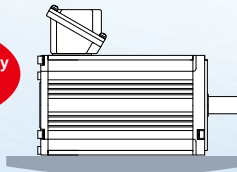

[Mass] When the mass of induction motors is 1

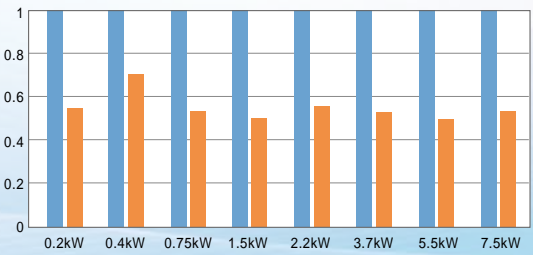

Reduction of about **30% to 50%**

■ Induction motor ■ EM-A

Energy saving

- Energy-saving motors meeting the efficiency class* IE5 for variable speed motors.

* According to the efficiency reference values (%) of variable speed motors based on IEC60034-30-2 (at the rated speed of 1801 to 6000 r/min).

Meeting the IE5 efficiency standard

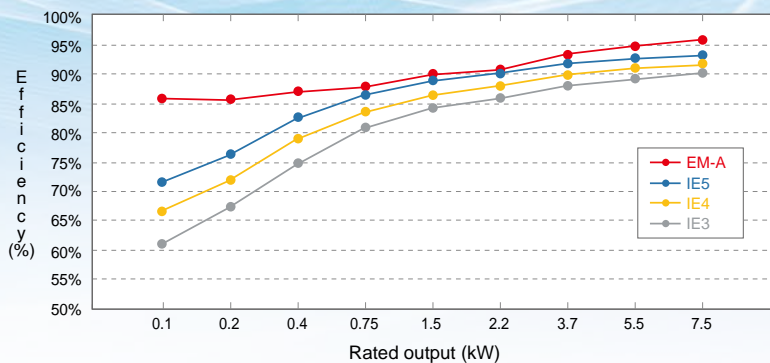

- The motors consume lower electric power and contribute to the reduction of energy charge, which reduces the CO₂ emission and contributes to the prevention of global warming.

<Estimation conditions>

Efficiency value when 10 motors are operated at the rated load for 8760 hr/year (= 24 hr/day × 365 days/year), the electricity rate is 14 yen/kWh, and the CO₂ emissions are 0.555 kg/kWh

* These data are for your reference.

For example, when 10 0.4-kW motors are used, the energy-saving efficiency is:

[Annual energy charge]

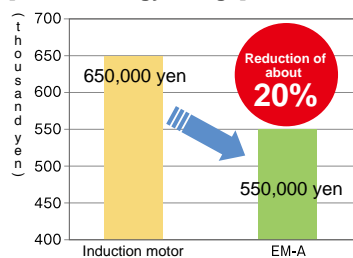

[Annual CO₂ emissions]

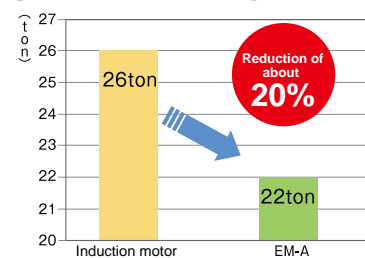

Globalization















EM-A Series magnetic motors do not require* the high efficiency certification in each country and can be easily applied to equipment to be exported.



High efficiency regulations in each country

In 2008, the efficiency classification for induction motors (IEC60034-30) was established as an international standard, and the certification system for high efficiency regulations has been set up in each country. In the future, the high efficiency regulations will be globally applied, and it will be required to acquire the certification.

* Information as of April 2021 (Energy efficiency label is required for China.)

Country/region	Standard	Induction motor efficiency class	EM-A Series
China 	GB30253-2013	Grade GB3 or higher	Applicable
	GB18613-2020	Grade GB3 or higher	
US 	NEMA MG1-12-12	IE3	Not applicable
Canada 	CSA C390	IE3	
EU 	IEC60034-30-1(2014)	IE3	
Australia 	AS/NZ1359.5:2004	IE2	
New Zealand 			
Taiwan 	Chinese National Standard (CNS) 14400	IE3	
Korea 	KSC 4202	IE3	
Brazil 	ABNT NBR 17094-1	IE2	
Vietnam 	TCVN 6627-30:2011 TCVN 7540-1:2013	IE1	
Mexico 	NOM-016-ENER-2010	IE3	
Saudi Arabia 	SASO IEC 60034-30:2013 (IEC 60034-30 Ed.1.0:2008)	IE3	
Russia 	Unknown	IE3	
India 	IS 12615:2011 Energy Efficient Induction Motors– Three Phase Squirrel Cage	IE2	
Singapore 	IEC 60034-2-1:2014(method 2-1-1B) or IEEE 112:2004(method B)	IE3	

* Because some countries require safety standard certification, please contact us regarding the status of compliance with overseas standards.

* Information as of April 2021

* Acquisition of certification for China standard GB30253-2013 (Energy efficiency label) is planned.

High performance

Mitsubishi has developed a unique salient-pole core to realize high-performance magnetic motors that can ensure positioning and speed control without a sensor.

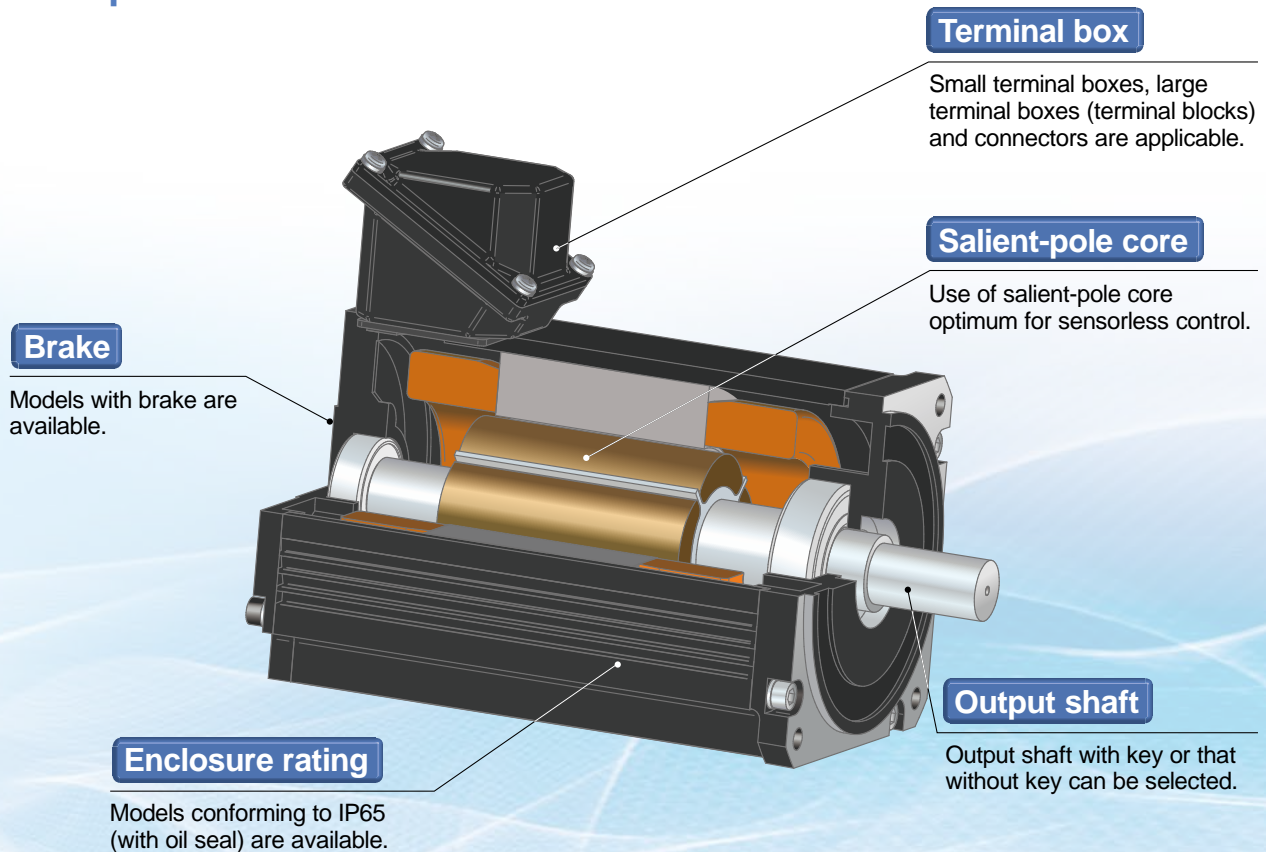

Newly developed salient-pole magnetic motors

EM-A Series include newly developed magnetic motors using the patented salient-pole core^{*1}. The rotor consists of the salient-pole core and surface-mounted permanent magnet, and therefore the motor inductance changes depending on the rotational position. This change in inductance is applied to the sensorless control.

The combination of the newly developed salient-pole magnetic motor and Mitsubishi's unique high-performance sensorless control technique realizes high precision speed control and positioning control without a sensor (encoder). ^{*1} Patent No. 5646119

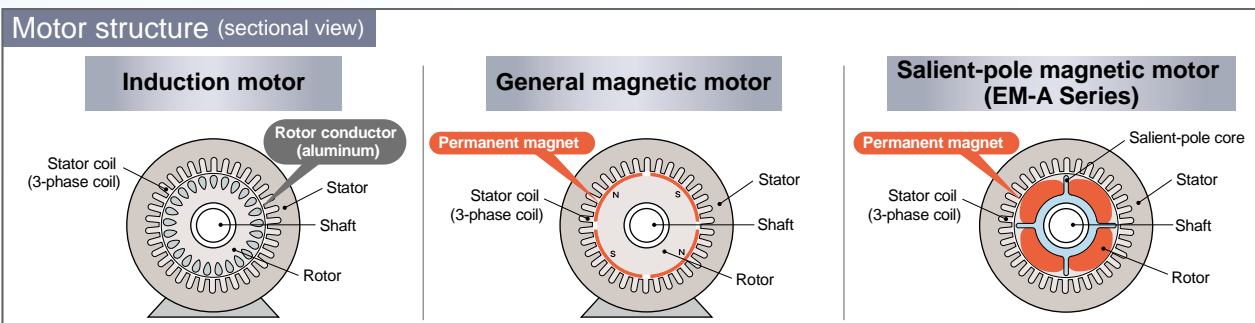

Speed control

Speed control comparable to that by servo motors is realized without a sensor.

Speed variation rate:
±0.05%

* In the case of digital input

Max. torque:
200%

- EM-A Series realize high precision speed control by using Mitsubishi's unique PM sensorless vector control that does not cause significant speed variation even under changing load.
- The series can be applied to high precision transfer systems of semiconductor and liquid crystal manufacturing lines.
- Operation resistant to load fluctuation at stable speed.
Speed variation: ±0.05% *1
Speed control range: 1:1300
- The servo lock function generates holding torque when the motor stops and can prevent movement by external force.

*1: When load changes between 0 and 100%

$$\text{Speed variation} = \frac{\text{Actual rotation speed} - \text{command rotation speed}}{\text{Rated speed}} \times 100(\%)$$

[Operating torque characteristics]

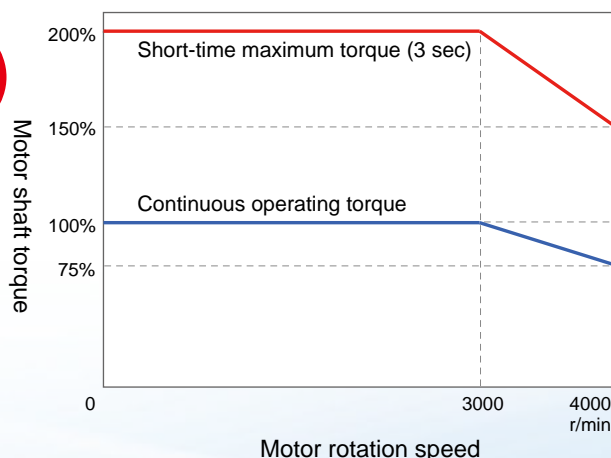

* Torque characteristics may decline when the input voltage is low.

* The continuous operating torque is 90% at 10 r/min or less (1.5 kW or more).

* When high-load operation is performed in low-speed areas (in particular at 15 r/min or less (0.75 kW or less) or 10 r/min or less (1.5 kW or more)), the electronic thermal protector (E.THT or ETHM) may activate and it may not be possible to produce torque in the short-time operating area.

Positioning control

Positioning can be performed without an encoder.

- The combination of the newly developed salient-pole magnetic motor and Mitsubishi's unique high-performance sensorless control technique realizes high precision speed control and positioning control without a sensor (encoder).
- The positioning function (point table method) using a contact signal and CC-Link communication (optional) can be used.*1
The use of the pulse-train input option realizes positioning by using a programmable controller positioning module.

Positioning accuracy:
200p/rev

Positioning accuracy: 200 p/rev *2

Drive module position command resolution: 4096 p/rev

*1: The function is not applicable to absolute position detection systems.

*2: When the input voltage is 200 to 220 V AC and the wiring length is 5 m or less.

EM-A Series lineup

Series name

Motor only

EM	A	M	F	B	K	
EM: Global PM motor	A: A series	M: Motor only	F: Flange type	None: Without brake B: With brake	None: Without key K: With key	None: IP44 W: IP65 ^{*1} T: With terminal block (specifications without brake only)

Output	Rotation Speed	Voltage	Special specification ^{*3}
0.1 kW 0.2 kW 0.4 kW 0.75kW 1.5 kW 2.2 kW 3.7 kW 5.5 kW 7.5 kW	3000 r/min	200 V	Terminal box socket direction Brake 24 V DC UL/cUL,EN ^{*2}

*1: Release of 3.7 to 7.5 kW IP65 (W) with brake is planned.

*2: Compliance with the UL/cUL standard and EN standard (CE mark) is available with the same special specifications.
Acquisition for 3.7 to 7.5 kW is planned.

*3: Acquisition of China standard GB30253-2013 certification is planned.

Specifications

●EM-A Series (200 V class)

Output (kW)		0.1	0.2	0.4	0.75	1.5	2.2	3.7	5.5	7.5
Number of poles		4P				6P				
Compatible drive unit	Capacity (□K)	0.1	0.2	0.4	0.75	1.5	2.2	3.7	5.5	7.5
	FR-E720EX-□K	○	○	○	○	○	○	○	-	-
	FR-E820-□K	△	△	△	△	△	△	△	○	○
Rated motor rotation speed(r/min)		3000								
Max. motor rotation speed(r/min)		4000								
Motor rated voltage(V)		130	135	160	165	170	165	160	170	165
Motor rated current(A)		0.55	1.1	1.8	3.3	6.1	9.3	16.5	22	31
Motor rated torque(Nm)		0.32	0.64	1.27	2.39	4.78	7.0	11.8	17.5	23.9
Motor max. torque(%)		200								
Positioning accuracy(p/rev)		200								
Rating		Continuous								
Allowable output shaft overhang load(N) ³		392		490		686		1470		
Allowable output shaft thrust load(N)		196		294		490		980		
Heat resistance class		130(B)						155(F)		
Moment of inertia J (×10 ⁻⁴ kg·m ²)	Without brake	1.51	1.51	3.72	5.43	11.4	16.5	62	85.5	109
	With brake	1.53	1.53	4.03	5.74	12.2	17.3	66.5	90	113.5
Recommended moment of load inertia ratio		10× or less								
Enclosure rating		Indoor type (IP44) ^{*1} , Dust and waterproof type (IP65) ^{*1 *2}								
Enclosure structure		Totally-enclosed self-cooling type								
Ambient temperature/relative humidity		0 to +40°C / RH 90% or less								
Altitude		Up to 1000 m above sea level								
Vibration		Constant 4.9 m/s ² , instantaneous 9.8 m/s ² or less								
Brake type		DC spring holding type (IP44: 90 V DC, IP65: 24 V DC) (Brake torque 150% or more/allowable number of braking operations 1000 times/mechanical life 1,000,000 times)								
Paint color		Black (equivalent to Munsell N1.5)								
Weight(kg)	Without brake	2.9	2.9	4.9	6.4	9.5	11.7	22	28	34
	With brake	3.9	3.9	6.7	8.2	12.2	14.4	28	34	40

*1: Excludes part where shaft passes through.

*2: With EM-AMF□□W

*3: Load position is at center of output shaft.

○ : Model currently supporting △ : Support planned — : Not applicable

Outline dimensional drawings

EM-AMF 0.1kW

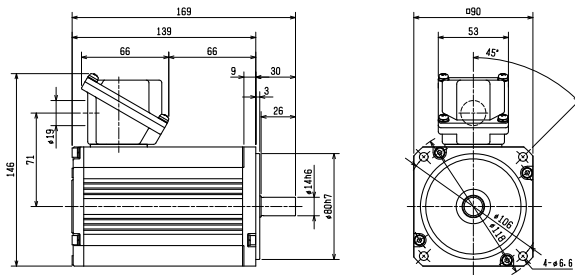

EM-AMF 0.2kW

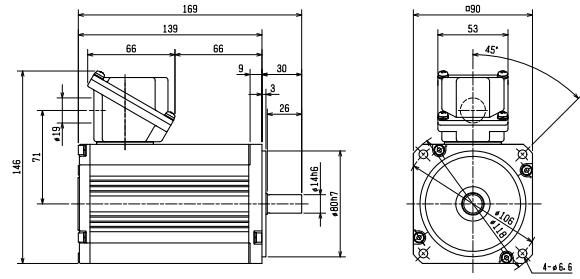

EM-AMF 0.4kW

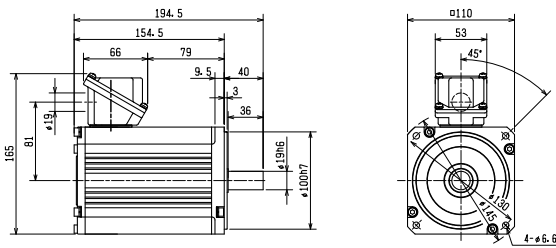

EM-AMF 0.75kW

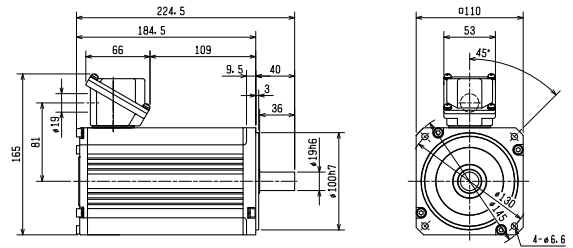

EM-AMF 1.5kW

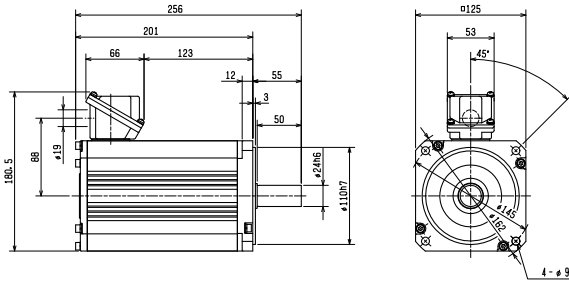

EM-AMF 2.2kW

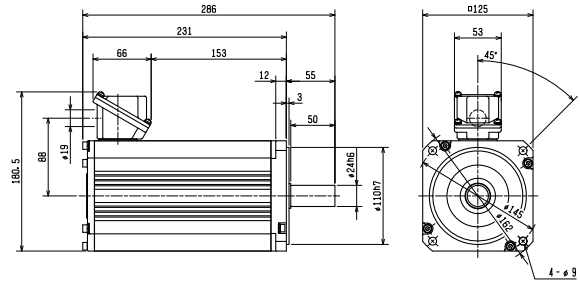

EM-AMF 3.7kW

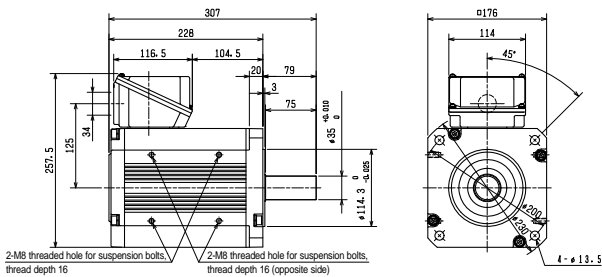

EM-AMF 5.5kW

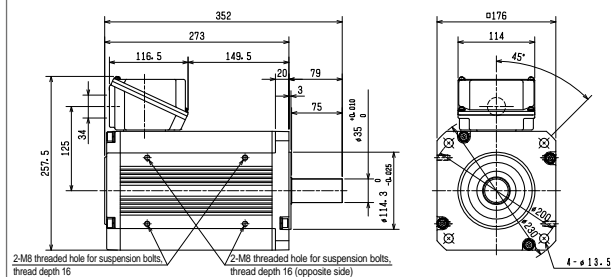

EM-AMF 7.5kW

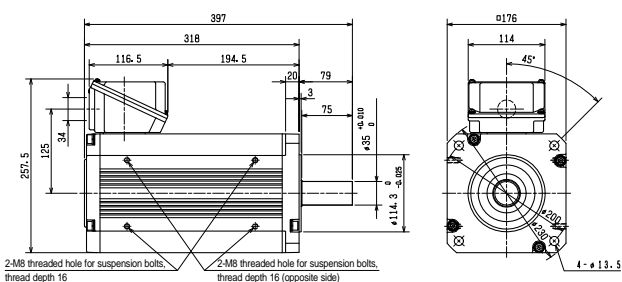

Outline dimensional drawings

EM-AMFB 0.1kW

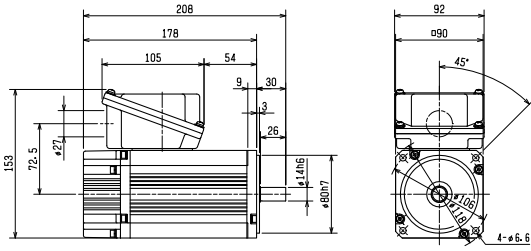

EM-AMFB 0.2kW

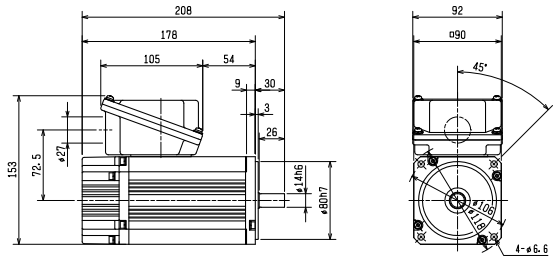

EM-AMFB 0.4kW

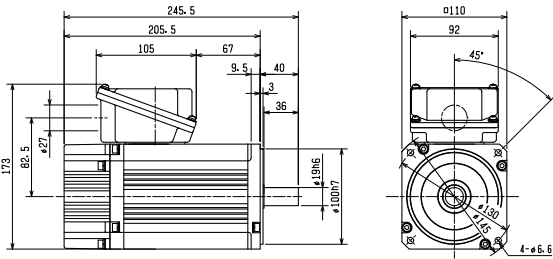

EM-AMFB 0.75kW

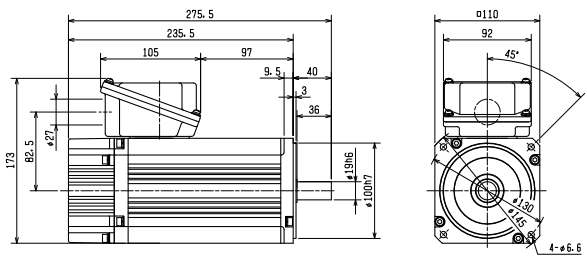

EM-AMFB 1.5kW

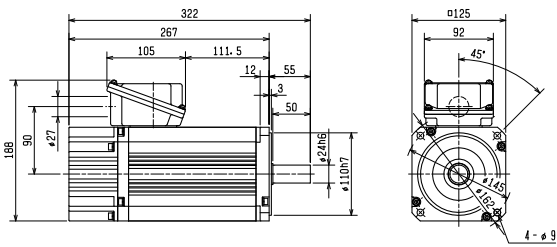

EM-AMFB 2.2kW

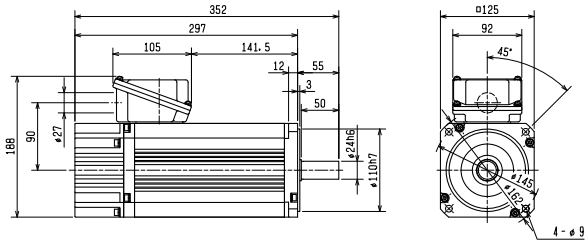

EM-AMFB 3.7kW

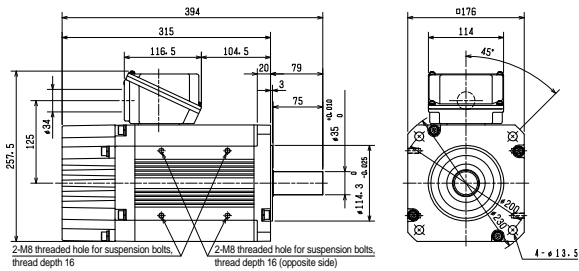

EM-AMFB 5.5kW

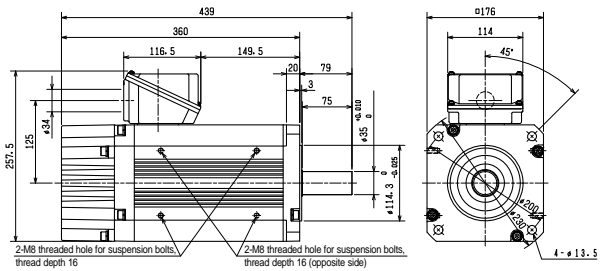

EM-AMFB 7.5kW

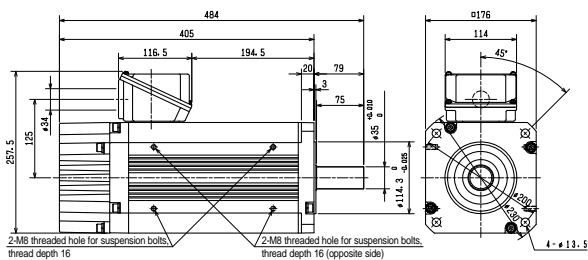

FREQROL-E700EX

Small and sophisticated drive modules



Lineup

FR - E720EX - 0.75K

Symbol	Voltage class	Symbol	Drive module capacity	Symbol	Specification of control circuit terminal
E720EX	3-phase 200-V class	0.1 to 2.2	Indicates the capacity [kW].	None	Standard control circuit terminal type (screwed type)
				NF	FL remote communication type



Conforming to UL (UL508C), cUL (CSA C22.2 No.14), EC Directive (CE mark) and Radio Waves Act (Republic of Korea) *1

Human- and environment-friendly drive modules conforming to RoHS Directive.

*1 The products compatible with FL remote communication do not conform to the Radio Waves Act (Republic of Korea).

Rating

3-phase
200-V power supply

Model name: FR-E720EX-□K(NF)		0.1	0.2	0.4	0.75	1.5	2.2	3.7
Output	Rated current (A)	0.8	1.5	3	5	8	11	17.5
	Overload current rating	150% 60 s, 200% 3 s (based on motor rated current, inverse-time-limit characteristic)						
Power supply	Rated input AC voltage/frequency	3-phase, 200 to 240 V, 50 Hz/60 Hz						
	Allowable range of AC voltage fluctuation	170 to 264 V, 50 Hz/60 Hz						
	Allowable range of frequency fluctuation	±5%						
Enclosure rating		Closed type (IP20) *1						
Cooling method		Self-cooling				Forced air cooling		
Approximate weight (kg)		0.5	0.5	0.7	1.0	1.4	1.4	1.7

*1 The products compatible with FL remote communication are open type (IP00).

Outline dimensional drawings

FR-E720EX-0.1K(NF) to 0.75K(NF)

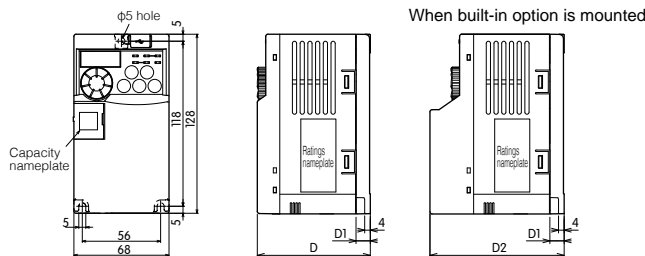

(Unit: mm)

Drive unit model name	D	D1	D2	
			When FR-A7NC E kit is mounted	When FR-E7DS is mounted
FR-E720EX-0.1K and -0.2K	80.5	10	97.6	108
FR-E720EX-0.1KNF and -0.2KNF	89.5		—	—
FR-E720EX-0.4K	112.5	42	129.6	140
FR-E720EX-0.4KNF	121.5		—	—
FR-E720EX-0.75K	132.5	62	149.6	160
FR-E720EX-0.75KNF	141.5		—	—

FR-E720EX-1.5K(NF) and -2.2K(NF)

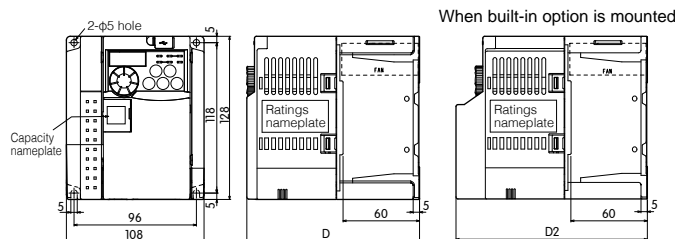

(Unit: mm)

Drive unit model name	D	D2	
		When FR-A7NC E kit is mounted	When FR-E7DS is mounted
FR-E720EX-1.5K and -2.2K	135.5	152.6	163
FR-E720EX-1.5KNF and -2.2KNF	144.5	—	—

FR-E720EX-3.7K(NF)

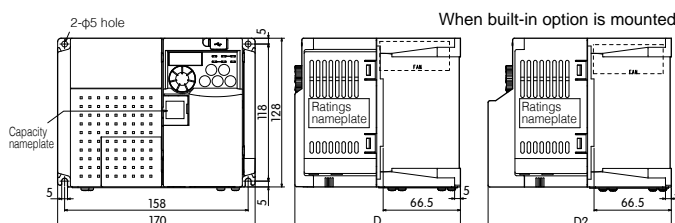

(Unit: mm)

Drive unit model name	D	D2		
		When FR-A7NC E kit is mounted	When FR-E7DS is mounted	When FR-A7AP-EX kit is mounted
FR-E720EX-3.7K	142.5	159.6	170	157.6
FR-E720EX-3.7KNF	151.5	—	—	—

* For the details of the drive modules, see the general catalog of sensorless servos (L(NA)06083-E(1703)MEE).

1

Operating in the speed control mode

The motor speed can be controlled in the same manner as when an inverter is used, and the motor can be operated at a specified speed with an external operation switch.

3-speed operation can be performed with an external operation switch.

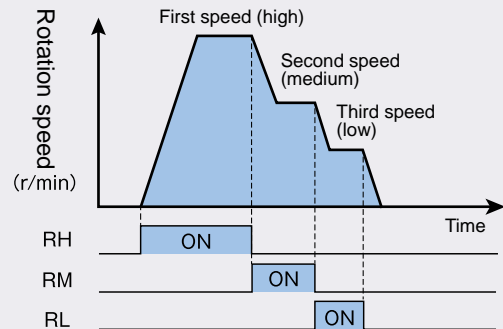

Operation procedure

- 1 Screen displayed when power is turned on**
 The monitor screen appears.
- 2 Speed setting**
 Turn on the high speed switch (RH).
- 3 Start → Acceleration → Constant speed**
 Turn on the start switch (STF or STR). The speed indicated on the display area will increase with the acceleration time Pr.7 and reach "3000" (3000 r/min). The [RUN] lamp is on during normal rotation and flashing during reverse rotation.
 ●When RM has been turned on, 1500 r/min is displayed. When RL has been turned on, 300 r/min is displayed.
- 4 Deceleration → Stop**
 Turn off the start switch (STF or STR).
 The speed indicated on the display area will decrease with the deceleration time Pr.8 and reach "0" (0 r/min), and the motor will stop. The [RUN] lamp will go out.
- 5 Speed setting (OFF)**
 Turn off the high speed switch (RH).

2

Operating in the position control mode

Position control can be performed without a sensor, and the motor can be operated for movement to a specified position with an external operation switch.

Operation example

Positioning operation can be performed with an external operation switch.

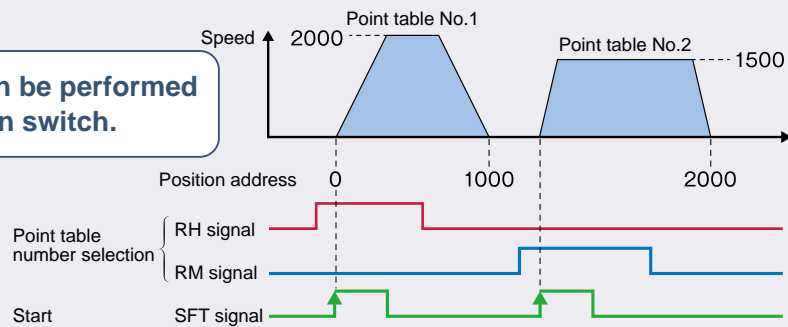

Operation procedure

- 1 **Screen displayed when power is turned on**
The monitor screen appears.
- 2 **Target position setting**
Turn on the high speed switch (RH).
- 3 **Servo on**
Turn on the low speed switch (SON).
- 4 **Positioning**
Turn on the start switch (STF).
The motor will run until the position specified in the point table is reached.
- 5 **Stop**
Turn off the start switch (STF).
- 6 **Servo off**
Turn off the low speed switch (SON).
- 7 **Target position setting (OFF)**
Turn off the high speed switch (RH).

For position control, the speed command is calculated in the way the difference between commanded position and present position is reaching to zero, and then the motor is started.

The position command can be set by the point table method.

The positioning operation can be performed by selecting a position command in the point table with an external operation switch.

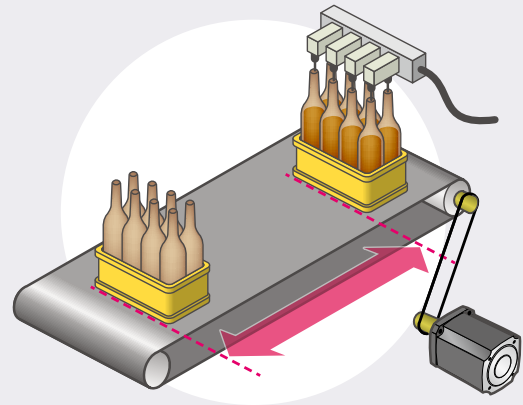

Connection example

Assign the external operation switch functions for position control.

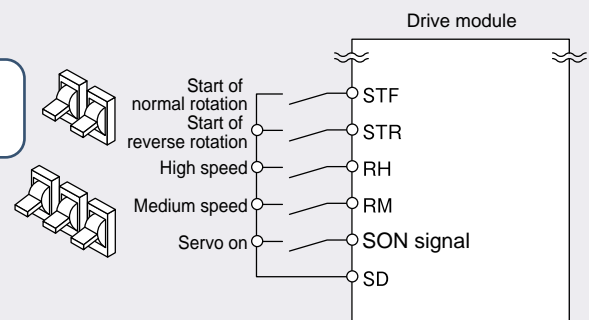

Create the point table.

Item	First positioning	Second positioning
Operating speed	2000r/min(Pr.4)	1500r/min(Pr.5)
Acceleration time	1.0s(Pr.578)	0.5s(Pr.580)
Deceleration time	1.0s(Pr.579)	0.5s(Pr.581)
Target position	1000(Pr.465)	2000(Pr.467)
Auxiliary function for positioning	10: Forward direction Incremental value command Independent (Pr.525)	11: Backward direction Incremental value command Independent (Pr.526)

Item	Setting
Pr.800 Control method selection	13: Position control
Pr.532 Home position return method	2: Data set method
Pr.537 Roll feed mode selection	1

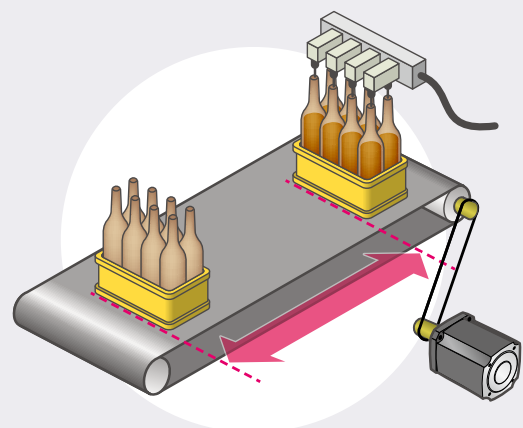

* For details, see the instruction manual for the drive module.

3

Introduction of positioning modules

An example of combination with a positioning module is introduced.

Operation example

Positioning by pulse-train input can be performed by combining FR-A7AP-EX (built-in option) and a programmable controller positioning module.

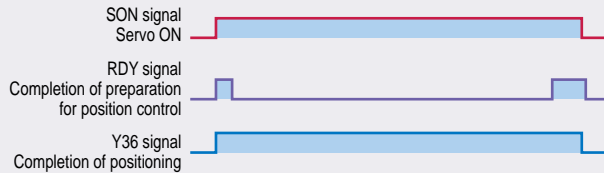
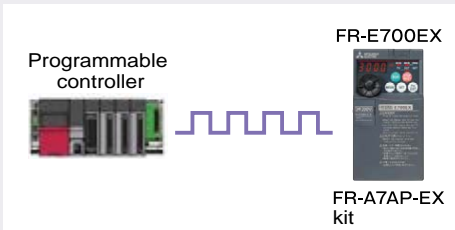
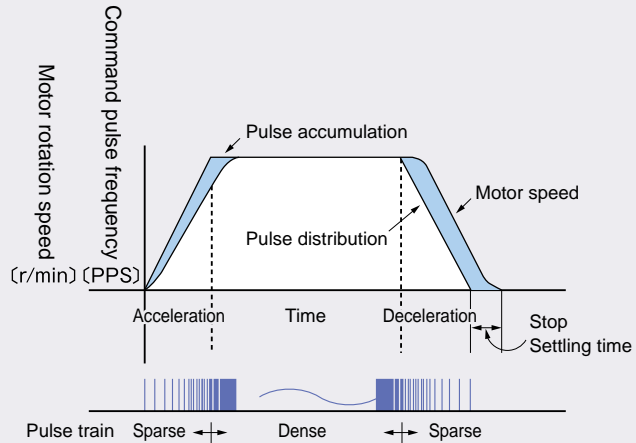

Wiring example Example of wiring of FR-A7AP-EX (built-in option) and positioning module

Connection with MELSEC iQ-R Series RD75D positioning module

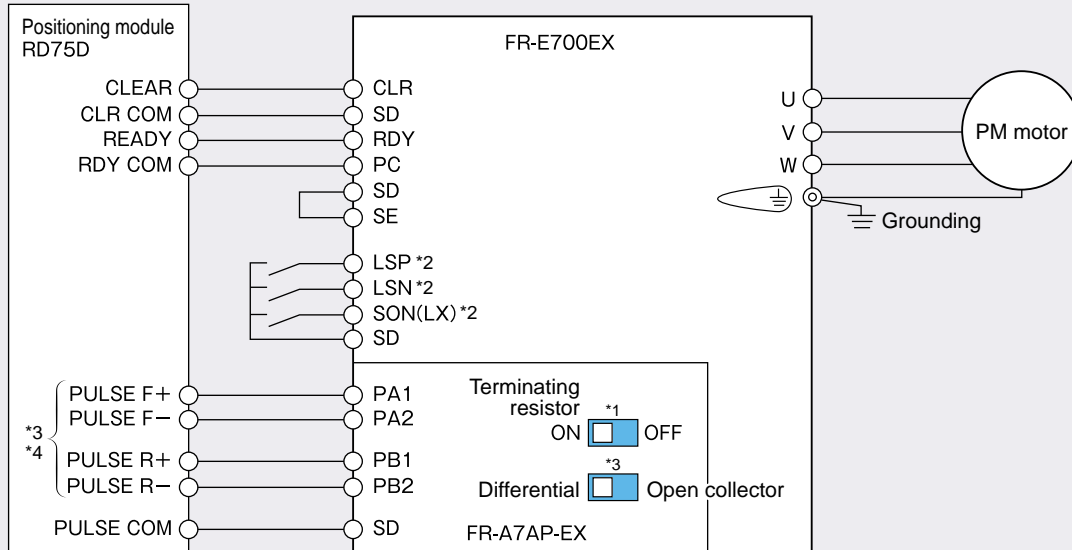

*1 When an open collector is used, set the terminating resistor selector switch to OFF (default).
 *2 Assign the functions with Pr.178 to Pr.184 (input terminal function selection).
 *3 The connection varies depending on the specifications for the pulse signals input from the positioning module. (This figure gives an example of connection with a differential line driver.)
 *4 When Pr.428 (command selection) is not set to "1,4," connect the positioning module terminals (PULSE F+, PULSE F-, PULSE R+ and PULSE R-) and the terminals of FR-A7AP-EX (PA1, PA2, PB1 and PB2) as shown in the wiring example. When Pr.428 is set to "1,4," connect the terminals PULSE R+ and PA1, PULSE R- and PA2, PULSE F+ and PB1, and PULSE F- and PB2.

Warranty

1. Warranty period and scope

In the event of a failure in the product which is the fault of our company occurring during the warranty period, Mitsubishi will provide free repair of the product through the dealer where the product was purchased or our service company. However, if it is necessary to dispatch a repair technician from Japan to an overseas destination, or to a remote island or equivalent distant destination, the customer will be charged the actual expenses required for technician dispatch.

[Warranty period]

The warranty period shall end either when 1 year has passed after installation at your company or the customer of your company, or 18 months after shipping from our factory (calculated starting from the date of manufacture), whichever period is shorter. The warranty period for a repaired part will not be extended beyond the pre-repair warranty period.

[Warranty scope]

(1) Failure diagnosis

Initial failure diagnosis shall in general be performed by your company. However upon request from your company, this work can be performed for a fee by Mitsubishi or our service network. In this case, if the results of discussion with your company conclude that Mitsubishi bears responsibility for the cause of the failure, then the charge for this diagnosis work will be waived but only in relation to the current product repairs or provision of replacement parts.

(2) Warranty contents

Even during the warranty period, a fee will be charged for repairs, part replacement, and technician dispatch in case of the following failures.

- (i) Failures caused by a problem in the installation or connection of equipment or other items that was performed by your company or a customer of your company
- (ii) Failures resulting from use of a lubrication oil other than that recommended by Mitsubishi
- (iii) Failures caused by factors such as inappropriate storage or handling, inattention, negligence, or the equipment and systems of your company
- (iv) Failures caused by modification or other changes to Mitsubishi products that were performed by your company
- (v) Failures caused by use of Mitsubishi products outside of the specification ranges
- (vi) Failures occurring when the conditions of use were normal but which may be regarded as preventable by performing the regular maintenance or replacement of consumable parts (bearings, oil seals, etc.) that is prescribed in the instruction manual or other documents
- (vii) Failures caused by unpreventable external factors such as fire or abnormal voltage, or by earthquake, lightning, wind or flood damage, or other natural disaster
- (viii) Failures resulting from a cause which could not have been predicted given the level of science and technology at the time the product was shipped from Mitsubishi
- (ix) Other failures recognized as not being the responsibility of Mitsubishi

The above services are provided only within Japan. Please refrain from requesting failure diagnosis and other services from overseas.

2. Exclusion of opportunity losses, secondary losses, and similar losses from warranty coverage

Regardless of whether within or outside of the warranty period, Mitsubishi shall bear no liability for any of the following occurring at your company, the customers or your company, or elsewhere on your company's side as a result of a failure of a Mitsubishi product: opportunity losses and loss of income; damages resulting from exceptional circumstances regardless of whether or not they were predicted by Mitsubishi; transport, interruption of business, and other secondary losses; accident compensation; damage to products other than Mitsubishi products; and other compensation for operations.

Be aware that the specifications listed in catalogs, instruction manuals, and technical materials may be changed without notice.

3. Repair period after the stop of production

For models (products) where production was stopped, repairs and supply of parts will be provided for a period of 7 years following the month in which production was stopped. However, be aware that parts which are produced using casting or forming molds may be replaced by parts that have equivalent functions.

The supply of products, including replacement products, will not be possible following the stop of production.

4. Changes to product specifications

Be aware that the specifications listed in catalogs, instruction manuals, technical materials, and other documents may be changed without notice.

5. Applications of the product

- (1) Use of the product is limited to applications where a failure or problem in the product will not result in a severe accident, and its use is permitted only when backups and failsafe functions have been systematically implemented in case a failure or problem occurs.
- (2) The product was designed and manufactured as a general-purpose product for ordinary industrial and other applications. Therefore, the product must not be used in applications which require a special quality assurance system, such as in nuclear power plants and other power plants operated by power companies, and other applications that have a large impact on the public, or in applications for railway companies or government offices. The product must not be used in applications which can be expected to have a large effect on lives or property, such as aviation, medical care, railways, combustion and fuel systems, manned transport systems, entertainment equipment, or safety equipment. However, when the customer understands and accepts that it cannot require any special quality for a particular application, Mitsubishi will consider permitting use in such applications. Please contact our office.

YOUR SOLUTION PARTNER

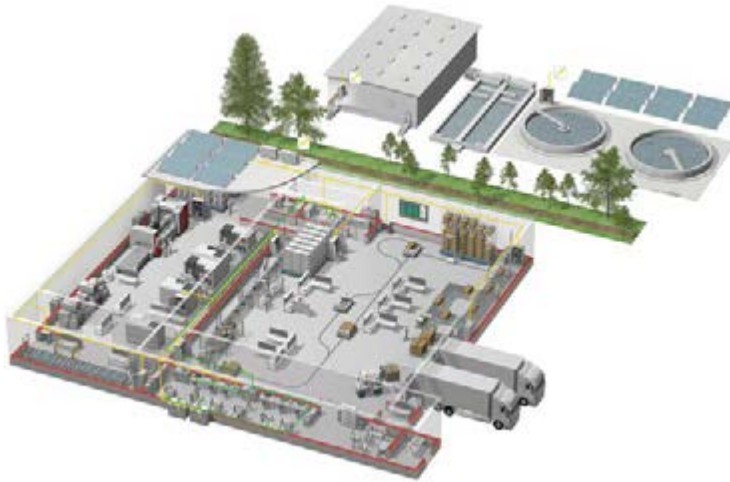

Mitsubishi Electric offers a wide range of automation equipment from PLCs and HMIs to CNC and EDM machines.

A NAME TO TRUST

Since its beginnings in 1870, some 45 companies use the Mitsubishi name, covering a spectrum of finance, commerce and industry.

The Mitsubishi brand name is recognized around the world as a symbol of premium quality.

Mitsubishi Electric Corporation, established in 1921, is active in space development, transportation, semi-conductors, energy systems, communications and information processing, audio visual equipment and home electronics, building and energy management and automation systems, and has 183 factories, laboratories and offices worldwide in over 140 countries.

This is why you can rely on Mitsubishi Electric automation solution - because we know first hand about the need for reliable, efficient, easy-to-use automation and control in our own factories.

As one of the world's leading companies with a global turnover of over 4 trillion Yen (over \$40 billion), employing over 146,000 people, Mitsubishi Electric has the resource and the commitment to deliver the ultimate in service and support as well as the best products.



Low voltage: MCCB, MCB, ACB



Medium voltage: VCB, VCC



Power monitoring, energy management



Compact and Modular Controllers



Inverters, Servos and Motors



Visualization: HMIs



Numerical Control (NC)



Industrial / Collaborative Robots

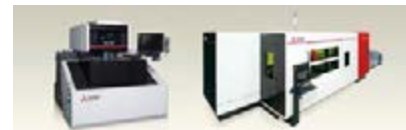

Processing machines: EDM, Lasers, IDS



Transformers, Air conditioning, Photovoltaic systems

* Not all products are available in all countries.

Global Partner. Local Friend.

mitsubishi **MITSUBISHI ELECTRIC CORPORATION** HEAD OFFICE: TOKYO BLDG., 2-7-3 MARUNOUCHI,
CHIYODA-KU, TOKYO 100-8310, JAPAN