



Programmable Controller



MELSEC iQ-F
series



Transition from MELSEC FX3G, FX3U,
FX3UC Series to MELSEC iQ-F Series Handbook

SAFETY PRECAUTIONS

(Read these precautions before use.)

Before using this product, please read this manual and the relevant manuals introduced in this manual carefully and pay full attention to safety in order to handle the product correctly.

This manual classifies the safety precautions into two categories: [ WARNING] and [ CAUTION].

 WARNING	Indicates that incorrect handling may cause hazardous conditions, resulting in death or severe injury.
 CAUTION	Indicates that incorrect handling may cause hazardous conditions, resulting in minor or moderate injury or property damage.

Depending on the circumstances, procedures indicated by [ CAUTION] may also cause severe injury.

It is important to follow all precautions for personal safety.

Store this manual in a safe place so that it can be read whenever necessary. Always forward it to the end user.

[DESIGN PRECAUTIONS]

WARNING

- Make sure to set up the following safety circuits outside the PLC to ensure safe system operation even during external power supply problems or PLC failure. Otherwise, malfunctions may cause serious accidents.
 - Most importantly, set up the following: an emergency stop circuit, a protection circuit, an interlock circuit for opposite movements (such as normal vs. reverse rotation), and an interlock circuit (to prevent damage to the equipment at the upper and lower positioning limits).
 - Note that when the CPU module detects an error, such as a watchdog timer error, during self-diagnosis, all outputs are turned off. Also, when an error that cannot be detected by the CPU module occurs in an input/output control block, output control may be disabled. External circuits and mechanisms should be designed to ensure safe machinery operation in such a case.
 - Note that the output current of the 24 V DC service power supply varies depending on the model and the absence/presence of extension modules. If an overload occurs, the voltage automatically drops, inputs in the PLC are disabled, and all outputs are turned off. External circuits and mechanisms should be designed to ensure safe machinery operation in such a case.
 - Note that when an error occurs in a relay, triac or transistor of an output circuit, the output might stay on or off. For output signals that may lead to serious accidents, external circuits and mechanisms should be designed to ensure safe machinery operation in such a case.
 - Construct an interlock circuit in the program so that the whole system always operates on the safe side before executing the control (for data change) of the PLC in operation.

Read the manual thoroughly and ensure complete safety before executing other controls (for program change, parameter change, forcible output and operation status change) of the PLC in operation. Otherwise, the machine may be damaged and accidents may occur due to erroneous operations.
 - In an output circuit, when a load current exceeding the current rating or an overcurrent caused by a load short-circuit flows for a long time, it may cause smoke and fire. To prevent this, configure an external safety circuit, such as a fuse.
 - For the operating status of each station after a communication failure of the network, refer to relevant manuals for the network. Incorrect output or malfunction may result in an accident.
-

[DESIGN PRECAUTIONS]

CAUTION

- When an inductive load such as a lamp, heater, or solenoid valve is controlled, a large current (approximately ten times greater than normal) may flow when the output is turned from off to on. Take proper measures so that the flowing current does not exceed the value corresponding to the maximum load specification of the resistance load.
 - After the CPU module is powered on or is reset, the time taken to enter the RUN status varies depending on the system configuration, parameter settings, and/or program size.
Design circuits so that the entire system will always operate safely, regardless of this variation in time.
 - Simultaneously turn on and off the power supplies of the CPU module and extension modules.
 - If a long-time power failure or an abnormal voltage drop occurs, the PLC stops, and output is turned off. When the power supply is restored, it will automatically restart (when the RUN/STOP/RESET switch is on the RUN side).
-

[Security Precautions]

WARNING

- To maintain the security (confidentiality, integrity, and availability) of the programmable controller and the system against unauthorized access, denial-of-service (DoS) attacks, computer viruses, and other cyberattacks from unreliable networks and devices via the network, take appropriate measures such as firewalls, virtual private networks (VPNs), and antivirus solutions.
-

[INSTALLATION PRECAUTIONS]

WARNING

- Make sure to cut off all phases of the power supply externally before attempting installation or wiring work. Failure to do so may cause electric shock or damage to the product.
 - Use the product within the generic environment specifications described in the User's Manual (Hardware) for the CPU module to be used.
Never use the product in areas with excessive dust, oily smoke, conductive dusts, corrosive gas (salt air, Cl₂, H₂S, SO₂ or NO₂), flammable gas, vibration or impacts, or expose it to high temperature, condensation, or rain and wind.
If the product is used in such conditions, electric shock, fire, malfunctions, deterioration or damage may occur.
-

[INSTALLATION PRECAUTIONS]

CAUTION

- Do not touch the conductive parts of the product directly. Doing so may cause device failures or malfunctions.
 - When drilling screw holes or wiring, make sure that cutting and wiring debris do not enter the ventilation slits of the PLC. Failure to do so may cause fire, equipment failures or malfunctions.
 - For the product supplied together with a dust proof sheet, the sheet should be affixed to the ventilation slits before the installation and wiring work to prevent foreign objects such as cutting and wiring debris.
However, when the installation work is completed, make sure to remove the sheet to provide adequate ventilation. Failure to do so may cause fire, equipment failures or malfunctions.
 - Install the product on a flat surface. If the mounting surface is rough, undue force will be applied to the PC board, thereby causing nonconformities.
 - Install the product securely using a DIN rail or mounting screws.
 - Connect the expansion board and expansion adapter securely to their designated connectors. Loose connections may cause malfunctions.
 - Make sure to affix the expansion board with tapping screws.
Tightening torque should follow the specifications in the manual.
If the screws are tightened outside of the specified torque range, poor connections may cause malfunctions.
 - Work carefully when using a screwdriver such as installation of the product. Failure to do so may cause damage to the product or accidents.
 - Connect the extension cables, peripheral device cables, input/output cables and battery connecting cable securely to their designated connectors. Loose connections may cause malfunctions.
 - When using an SD memory card, insert it into the SD memory card slot. Check that it is inserted completely. Poor contact may cause malfunction.
 - Turn off the power to the PLC before attaching or detaching the following devices. Failure to do so may cause equipment failures or malfunctions.
 - Peripheral devices, expansion board, expansion adapter, and connector conversion adapter
 - Extension modules, bus conversion module and connector conversion module
 - Battery
-

[WIRING PRECAUTIONS]

WARNING

- Make sure to cut off all phases of the power supply externally before attempting installation or wiring work. Failure to do so may cause electric shock or damage to the product.
 - Make sure to attach the terminal cover, provided as an accessory, before turning on the power or initiating operation after installation or wiring work. Failure to do so may cause electric shock.
 - The temperature rating of the cable should be 80°C or more. It may differ depending on the extension devices. For details, refer to the user's manual of the extension devices.
 - Make sure to wire the screw terminal block in accordance with the following precautions. Failure to do so may cause electric shock, equipment failures, a short-circuit, wire breakage, malfunctions, or damage to the product.
 - The disposal size of the cable end should follow the dimensions described in the manual.
 - Tightening torque should follow the specifications in the manual.
 - Tighten the screws using a Phillips-head screwdriver No. 2 (shaft diameter 6 mm or less). Make sure that the screwdriver does not touch the partition part of the terminal block.
 - Make sure to properly wire to the terminal block (European type) in accordance with the following precautions. Failure to do so may cause electric shock, equipment failures, a short-circuit, wire breakage, malfunctions, or damage to the product.
 - The disposal size of the cable end should follow the dimensions described in the manual.
 - Tightening torque should follow the specifications in the manual.
 - Twist the ends of stranded wires and make sure that there are no loose wires.
 - Do not solder-plate the electric wire ends.
 - Do not connect more than the specified number of wires or electric wires of unspecified size.
 - Affix the electric wires so that neither the terminal block nor the connected parts are directly stressed.
 - Make sure to properly wire to the spring clamp terminal block in accordance with the following precautions. Failure to do so may cause electric shock, equipment failures, a short-circuit, wire breakage, malfunctions, or damage to the product.
 - The disposal size of the cable end should follow the dimensions described in the manual.
 - Twist the ends of stranded wires and make sure that there are no loose wires.
 - Do not solder-plate the electric wire ends.
 - Do not connect more than the specified number of wires or electric wires of unspecified size.
 - Affix the electric wires so that neither the terminal block nor the connected parts are directly stressed.
-

[WIRING PRECAUTIONS]

CAUTION

- Do not supply power to the [24+] and [24V] terminals (24 V DC service power supply) on the CPU module or extension modules. Doing so may cause damage to the product.
 - Perform class D grounding (grounding resistance: 100 Ω or less) to the grounding terminal on the CPU module or extension modules with a wire 2 mm² or thicker.
Do not use common grounding with heavy electrical systems (refer to the User's Manual (Hardware) for the CPU module to be used).
 - Connect the power supply wiring to the dedicated terminals described in this manual. If an AC power supply is connected to a DC input/output terminal or DC power supply terminal, the PLC will burn out.
 - Do not wire vacant terminals externally. Doing so may cause damage to the product.
 - Install module so that excessive force will not be applied to terminal blocks, power connectors, I/O connectors, communication connectors, or communication cables. Failure to do so may result in wire damage/breakage or PLC failure.
 - Make sure to observe the following precautions in order to prevent any damage to the machinery or accidents due to malfunction of the PLC caused by abnormal data written to the PLC due to the effects of noise.
 - Do not bundle the power line, control line and communication cables together with or lay them close to the main circuit, high-voltage line, load line or power line. As a guideline, lay the power line, control line and communication cables at least 100 mm away from the main circuit, high-voltage line, load line or power line.
 - Ground the shield of the shielded wire or shielded cable at one point on the PLC. However, do not use common grounding with heavy electrical systems.
 - Ground the shield of the analog input/output cable in accordance with the manuals of each model. However, do not use common grounding with heavy electrical systems.
-

[STARTUP AND MAINTENANCE PRECAUTIONS]

WARNING

- Do not touch any terminal while the PLC's power is on. Doing so may cause electric shock or malfunctions.
 - Before cleaning or retightening terminals, cut off all phases of the power supply externally. Failure to do so in the power ON status may cause electric shock.
 - Before modifying the program in operation, forcible output, running or stopping the PLC, read through this manual carefully, and ensure complete safety. An operation error may damage the machinery or cause accidents.
 - Do not change the program in the PLC from two or more peripheral equipment devices at the same time. (i.e. from an engineering tool and a GOT) Doing so may cause destruction or malfunction of the PLC program.
 - Use the battery for memory backup in conformance to the User's Manual (Hardware) for the CPU module to be used.
 - Use the battery for the specified purpose only.
 - Connect the battery correctly.
 - Do not charge, disassemble, heat, put in fire, short-circuit, connect reversely, weld, swallow or burn the battery, or apply excessive forces (vibration, impact, drop, etc.) to the battery.
 - Do not store or use the battery at high temperatures or expose to direct sunlight.
 - Do not expose to water, bring near fire or touch liquid leakage or other contents directly.
 - When replacing the battery, make sure to use our specified product (FX3U-32BL).
 - When a battery error occurs ("BAT" LED is lit in red), follow the description in this manual.
- Incorrect handling of the battery may cause heat excessive generation, bursting, ignition, liquid leakage or deformation, and lead to injury, fire or failures and malfunction of facilities and other equipment.
-

[STARTUP AND MAINTENANCE PRECAUTIONS]

CAUTION

- Do not disassemble or modify the PLC. Doing so may cause fire, equipment failures, or malfunctions. For repair, contact your local Mitsubishi Electric representative.
 - After the first use of the SD memory card, do not insert/remove the memory card more than 500 times. 500 times or more may cause malfunction.
 - Turn off the power to the PLC before connecting or disconnecting any extension cable. Failure to do so may cause equipment failures or malfunctions.
 - Turn off the power to the PLC before attaching or detaching the following devices. Failure to do so may cause equipment failures or malfunctions.
 - Peripheral devices, expansion board, expansion adapter, and connector conversion adapter
 - Extension modules, bus conversion module and connector conversion module
 - Battery
 - Do not use the chemicals for cleaning.
 - If there is the possibility of touching the PLC inside a control panel in maintenance, make sure to discharge to avoid the influence of static electricity.
 - Since there are risks such as burn injuries, please do not touch the surface of the equipment with bare hands when it is operating in an environment which exceeds ambient temperature of 50°C.
-

[OPERATION PRECAUTIONS]

CAUTION

- Construct an interlock circuit in the program so that the whole system always operates on the safe side before executing the control (for data change) of the PLC in operation. Read the manual thoroughly and ensure complete safety before executing other controls (for program change, parameter change, forcible output and operation status change) of the PLC in operation. Otherwise, the machine may be damaged and accidents may occur due to erroneous operations.
-

[DISPOSAL PRECAUTIONS]

CAUTION

- Please contact a certified electronic waste disposal company for the environmentally safe recycling and disposal of your device.
 - When disposing of batteries, separate them from other waste according to local regulations. For details of the Battery Directive in EU countries, refer to the User's Manual (Hardware) for the CPU module to be used.
-

[TRANSPORTATION PRECAUTIONS]

CAUTION

- When transporting the PLC with the optional battery, turn on the PLC before shipment, confirm that the battery mode is set using a parameter and the BAT LED is OFF, and check the battery life. If the PLC is transported with the BAT LED ON or the battery exhausted, the battery-backed data may be unstable during transportation.
 - The PLC is a precision instrument. During transportation, avoid impacts larger than those specified in the general specifications of the User's Manual (Hardware) for the CPU module to be used by using dedicated packaging boxes and shock-absorbing pallettes. Failure to do so may cause failures in the PLC. After transportation, verify operation of the PLC and check for damage of the mounting part, etc.
 - When transporting lithium batteries, follow required transportation regulations. For details on the regulated products, refer to the User's Manual (Hardware) for the CPU module to be used.
 - When fumigants that contain halogen materials such as fluorine, chlorine, bromine, and iodine are used for disinfecting and protecting wooden packaging from insects, they cause malfunction when entering our products. Please take necessary precautions to ensure that remaining materials from fumigant do not enter our products, or treat packaging with methods other than fumigation (heat method). Additionally, disinfect and protect wood from insects before packing products.
-

INTRODUCTION

This Replacement Manual describes CPU module and extension device model selection for replacement from the MELSEC FX3G/FX3U/FX3UC Series to the MELSEC iQ-F Series.

When replacing from the MELSEC FX3G/FX3U/FX3UC Series to the MELSEC iQ-F Series, some items will be necessary to consider beforehand such as the replacement procedure, installation location, comparing specifications of the existing module and the planned replacing module, and how to replace the network. For smooth replacement, please carefully consider beforehand.

Regarding use of this product

- This product has been manufactured as a general-purpose part for general industries, and has not been designed or manufactured to be incorporated in a device or system used in purposes related to human life.
- Before using the product for special purposes such as nuclear power, electric power, aerospace, medicine or passenger movement vehicles, consult Mitsubishi Electric.
- This product has been manufactured under strict quality control. However when installing the product where major accidents or losses could occur if the product fails, install appropriate backup or failsafe functions in the system.

Note

- If in doubt at any stage during the installation of the product, always consult a professional electrical engineer who is qualified and trained in the local and national standards. If in doubt about the operation or use, please consult the nearest Mitsubishi Electric representative.
- Since the examples indicated by this manual, technical bulletin, catalog, etc. are used as a reference, please use it after confirming the function and safety of the equipment and system. Mitsubishi Electric will accept no responsibility for actual use of the product based on these illustrative examples.
- This manual content, specification etc. may be changed, without a notice, for improvement.
- The information in this manual has been carefully checked and is believed to be accurate; however, if you notice a doubtful point, an error, etc., please contact the nearest Mitsubishi Electric representative. When doing so, please provide the manual number given at the end of this manual.

MEMO

CONTENTS

SAFETY PRECAUTIONS	1
INTRODUCTION	8
RELEVANT MANUALS	12
TERMS	12
GENERIC TERMS AND ABBREVIATIONS	13
CHAPTER 1 Outline	15
1.1 Outline of the MELSEC iQ-F Series	15
Outstanding Performance	15
Superior Drive Control	15
Improved Programming Environment	16
1.2 Substitute Models	16
Selection and Replacement of the Models	17
CHAPTER 2 Replacement from FX3G to FX5S	19
2.1 Outline	19
2.2 Replacement Procedure	19
2.3 Selection of Substitute Models	20
Recommended Substitute Models	20
Precautions Regarding the Hardware	24
2.4 Conversion of the Projects	26
Operation Method for Replacing Projects	26
Precautions when Converting the Projects	29
Precautions when Replacing the Parameters	29
Precautions when Replacing Other Functions	29
2.5 Replacement of the PLC	33
CHAPTER 3 Replacement from FX3G to FX5UJ	34
3.1 Outline	34
3.2 Replacement Procedure	34
3.3 Selection of Substitute Models	35
Recommended Substitute Models	35
Precautions Regarding the Hardware	39
3.4 Conversion of the Projects	41
Operation Method for Replacing Projects	41
Precautions when Converting the Projects	43
Precautions when Replacing the Parameters	43
Precautions when Replacing Other Functions	44
3.5 Replacement of the PLC	48
CHAPTER 4 Replacement from FX3U to FX5UJ	49
4.1 Outline	49
4.2 Replacement Procedure	49
4.3 Selection of Substitute Models	50
Recommended Substitute Models	50
Precautions Regarding the Hardware	54
4.4 Conversion of the Projects	56
Operation Method for Replacing Projects	56

Precautions when Converting the Projects	58
Precautions when Replacing the Parameters	58
Precautions when Replacing Other Functions	59
4.5 Replacement of the PLC	62
CHAPTER 5 Replacement from FX3U to FX5U	63
5.1 Outline	63
5.2 Replacement Procedure	63
5.3 Selection of Substitute Models	64
Recommended Substitute Models.	64
Precautions Regarding the Hardware	68
5.4 Conversion of the Projects.	70
Operation Method for Replacing Projects	70
Precautions when Converting the Projects	72
Precautions when Replacing the Parameters	72
Precautions when Replacing Other Functions	73
5.5 Replacement of the PLC	76
CHAPTER 6 Replacement from FX3UC to FX5UC	77
6.1 Outline	77
6.2 Replacement Procedure	77
6.3 Selection of Substitute Models	78
Recommended Substitute Models.	78
Precautions Regarding the Hardware	82
6.4 Conversion of the Projects.	85
Operation Method for Replacing Projects	85
Precautions when Converting the Projects	87
Precautions when Replacing the Parameters	87
Precautions when Replacing Other Functions	88
6.5 Replacement of the PLC	91
APPENDIX	92
Appendix 1 Instruction Replacement List	92
Appendix 2 Precautions for Instruction Replacement	104
Appendix 3 Device Replacement List.	106
Appendix 4 Precautions for Device Replacement.	115
Appendix 5 Conversion of the SFC Program	116
Differences in Specifications After Replacement.	116
Operation Method for Replacing Projects	117
Precautions when Converting the Projects	120
Precautions when Replacing the Parameters	120
Precautions when Replacing the Program	120
INDEX	124
REVISIONS	126
WARRANTY	127
TRADEMARKS	128

RELEVANT MANUALS

MELSEC iQ-F Series

Manual name <manual number>	Description
MELSEC iQ-F FX5S/FX5UJ/FX5U/FX5UC User's Manual(Hardware) <SH-082452ENG>	Describes the details of hardware of the FX5 CPU module, including performance specifications, wiring, installation, and maintenance.
MELSEC iQ-F FX5 User's Manual (Application) <JY997D55401>	Describes the basic knowledge required for program design, functions of the CPU module, devices/labels, and parameters.
MELSEC iQ-F FX5 Programming Manual (Program Design) <JY997D55701>	Describes the specifications of ladder, ST, FBD/LD, and SFC programs, and labels.
MELSEC iQ-F FX5 Programming Manual (Instructions, Standard Functions/Function Blocks) <JY997D55801>	Describes the specifications of instructions and functions that can be used in programs.
MELSEC iQ-F FX5 User's Manual (Ethernet Communication) <JY997D56201>	Describes the Ethernet communication function of the CPU module built-in and the Ethernet module.
GX Works3 Operating Manual <SH-081215ENG>	Describes the system configuration, parameter settings, and online operations of GX Works3.
Transition from MELSEC FX3G, FX3U, FX3UC Series to MELSEC iQ-F Series Handbook <JY997D66201> (This manual)	Describes the transition from MELSEC FX3G/FX3U/FX3UC series to MELSEC iQ-F series.

MELSEC FX3G/FX3U/FX3UC Series

Manual name <manual number>	Description
FX3G Series User's Manual [Hardware Edition] <JY997D31301>	Describes hardware of FX3G Series, including input/output specifications, wiring, installation and maintenance.
FX3U Series User's Manual [Hardware Edition] <JY997D16501>	Describes hardware of FX3U Series, including input/output specifications, wiring, installation and maintenance.
FX3UC Series User's Manual [Hardware Edition] <JY997D28701>	Describes hardware of FX3UC Series, including input/output specifications, wiring, installation and maintenance.
GX Works2 Version 1 Operating Manual (Common) <SH-080779>	Explains system configuration, parameter settings, and online operations of GX Works2.

TERMS

Unless otherwise specified, this manual uses the following terms.

Terms	Description
Engineering tool	The product name of the software package for the MELSEC programmable controllers
SD memory card	An abbreviation for Secure Digital Memory Card. Device that stores data using flash memory.

GENERIC TERMS AND ABBREVIATIONS

Unless otherwise specified, this manual uses the following generic terms and abbreviations.

Generic term/abbreviation	Description
Analog adapter	A generic term for FX5-4AD-ADP, FX5-4DA-ADP, FX5-4AD-PT-ADP, FX5-4AD-TC-ADP, and FX5-4A-ADP
Battery	A generic term for FX3U-32BL
Bus conversion module	A generic term for bus conversion modules (extension cable type) and bus conversion modules (extension connector type)
Bus conversion module (extension cable type)	A generic term for FX5-CNV-BUS
Bus conversion module (extension connector type)	A generic term for FX5-CNV-BUSC
Communication adapter	A generic term for FX5-232ADP and FX5-485ADP
Communication board	A generic term for FX5-232-BD, FX5-485-BD, and FX5-422-BD-GOT
Communication function expansion board	A generic term for FX3G-232-BD, FX3G-485-BD, FX3G-485-BD-RJ, FX3G-422-BD, FX3U-232-BD, FX3U-485-BD, FX3U-422-BD, and FX3U-USB-BD
Connector conversion adapter	A generic term for FX5-CNV-BC
Connector conversion module	A generic term for connector conversion modules (extension cable type) and connector conversion modules (extension connector type)
Connector conversion module (extension cable type)	A generic term for FX5-CNV-IF
Connector conversion module (extension connector type)	A generic term for FX5-CNV-IFC
Expansion adapter	A generic term for adapters for FX5 CPU modules
Expansion board	A generic term for boards for FX5S CPU modules, FX5UJ CPU modules, and FX5U CPU modules
Extended extension cable	A generic term for FX5-30EC and FX5-65EC
Extension module	A generic term for FX5 extension modules, FX3 extension modules, extension modules (extension cable type), and extension modules (extension connector type)
Extension module (extension cable type)	A generic term for input modules (extension cable type), output modules (extension cable type), I/O modules (extension cable type), powered input/output modules, high-speed pulse input/output modules, extension power supply modules (extension cable type), connector conversion modules (extension cable type), intelligent function modules, safety extension modules, and bus conversion modules (extension cable type)
Extension module (extension connector type)	A generic term for input modules (extension connector type), output modules (extension connector type), I/O modules (extension connector type), extension power supply modules (extension connector type), connector conversion modules (extension connector type), and bus conversion modules (extension connector type)
Extension power supply module	A generic term for FX5 extension power supply modules and FX3 extension power supply modules
FX3	A generic term for FX3S, FX3G, FX3GC, FX3U, and FX3UC programmable controllers
FX3 extension module	A generic term for FX3 extension power supply modules and FX3 intelligent function modules
FX3 extension power supply module	A generic term for FX3U-1PSU-5V
FX3 intelligent function module	A generic term for FX3U-4AD, FX3U-4DA, FX3U-4LC, FX3U-1PG, FX3U-2HC, FX3U-16CCL-M, FX3U-64CCL, FX3U-128ASL-M, and FX3U-32DP
FX5	A generic term for FX5S, FX5UJ, FX5U, and FX5UC programmable controllers
FX5 CPU module	A generic term for FX5S CPU modules, FX5UJ CPU modules, FX5U CPU modules, and FX5UC CPU modules
FX5 extension module	A generic term for I/O modules, FX5 extension power supply modules, FX5 intelligent function modules, and FX5 safety extension modules
FX5 extension power supply module	A generic term for FX5 extension power supply modules (extension cable type) and FX5 extension power supply modules (extension connector type)
FX5 extension power supply module (extension cable type)	A generic term for FX5-1PSU-5V
FX5 extension power supply module (extension connector type)	A generic term for FX5-C1PS-5V
FX5 intelligent function module	A generic term for FX5-4AD, FX5-4DA, FX5-8AD, FX5-4LC, FX5-20PG-P, FX5-20PG-D, FX5-40SSC-G, FX5-80SSC-G, FX5-40SSC-S, FX5-80SSC-S, FX5-ENET, FX5-ENET/IP, FX5-CCLGN-MS, FX5-CCLIEF, FX5-CCL-MS, FX5-ASL-M, and FX5-DP-M
FX5 safety extension module	A generic term for safety main modules and safety expansion modules

Generic term/abbreviation	Description
FX5S CPU module	A generic term for FX5S-30MR/ES, FX5S-40MR/ES, FX5S-60MR/ES, FX5S-80MR/ES ^{*1} , FX5S-30MT/ES, FX5S-40MT/ES, FX5S-60MT/ES, FX5S-80MT/ES ^{*1} , FX5S-30MT/ESS, FX5S-40MT/ESS, FX5S-60MT/ESS, and FX5S-80MT/ESS ^{*1}
FX5U CPU module	A generic term for FX5U-32MR/ES, FX5U-32MT/ES, FX5U-32MT/ESS, FX5U-64MR/ES, FX5U-64MT/ES, FX5U-64MT/ESS, FX5U-80MR/ES, FX5U-80MT/ES, FX5U-80MT/ESS, FX5U-32MR/DS, FX5U-32MT/DS, FX5U-32MT/DSS, FX5U-64MR/DS, FX5U-64MT/DS, FX5U-64MT/DSS, FX5U-80MR/DS, FX5U-80MT/DS, and FX5U-80MT/DSS
FX5UC CPU module	A generic term for FX5UC-32MT/D, FX5UC-32MT/DSS, FX5UC-64MT/D, FX5UC-64MT/DSS, FX5UC-96MT/D, FX5UC-96MT/DSS, FX5UC-32MT/DS-TS, FX5UC-32MT/DSS-TS, and FX5UC-32MR/DS-TS
FX5UJ CPU module	A generic term for FX5UJ-24MR/ES, FX5UJ-24MT/ES, FX5UJ-24MT/ESS, FX5UJ-40MR/ES, FX5UJ-40MT/ES, FX5UJ-40MT/ESS, FX5UJ-60MR/ES, FX5UJ-60MT/ES, and FX5UJ-60MT/ESS
GOT	A generic term for Mitsubishi Electric Graphic Operation Terminal GOT1000 and GOT2000 series
GX Works3	The product name of the software package, SWnDND-GXW3, for the MELSEC programmable controllers (The 'n' represents a version.)
High-speed pulse input/output module	A generic term for FX5-16ET/ES-H and FX5-16ET/ESS-H
I/O module	A generic term for input modules, output modules, I/O modules, powered input/output modules, and high-speed pulse input/output modules
Input module	A generic term for input modules (extension cable type) and input modules (extension connector type)
Input module (extension cable type)	A generic term for FX5-8EX/ES and FX5-16EX/ES
Input module (extension connector type)	A generic term for FX5-C16EX/D, FX5-C16EX/DS, FX5-C32EX/D, FX5-C32EX/DS, and FX5-C32EX/DS-TS
Input/output module	A generic term for input/output modules (extension cable type) and input/output modules (extension connector type)
Input/output module (extension cable type)	A generic term for FX5-16ER/ES, FX5-16ET/ES, and FX5-16ET/ESS
Input/output module (extension connector type)	A generic term for FX5-C32ET/D, FX5-C32ET/DSS, FX5-C32ET/DS-TS, and FX5-C32ET/DSS-TS
Intelligent function module	A generic term for FX5 intelligent function modules and FX3 intelligent function modules
Intelligent module	An abbreviation for intelligent function modules
Output module	A generic term for output modules (extension cable type) and output modules (extension connector type)
Output module (extension cable type)	A generic term for FX5-8EYR/ES, FX5-8EYT/ES, FX5-8EYT/ESS, FX5-16EYR/ES, FX5-16EYT/ES, and FX5-16EYT/ESS
Output module (extension connector type)	A generic term for FX5-C16EYT/D, FX5-C16EYT/DSS, FX5-C16EYR/D-TS, FX5-C32EYT/D, FX5-C32EYT/DSS, FX5-C32EYT/D-TS, and FX5-C32EYT/DSS-TS
Peripheral device	A generic term for engineering tools and GOTs
Powered input/output module	A generic term for FX5-32ER/ES, FX5-32ET/ES, FX5-32ET/ESS, FX5-32ER/DS, FX5-32ET/DS, and FX5-32ET/DSS
Safety expansion module	A generic term for expansion modules to be connected to a safety main module
Safety input expansion module	A generic term for FX5-SF-8DI4
Safety main module	A generic term for FX5-SF-MU4T5
SD memory card	A generic term for NZ1MEM-2GBSD, NZ1MEM-4GBSD, NZ1MEM-8GBSD, NZ1MEM-16GBSD, L1MEM-2GBSD and L1MEM-4GBSD memory cards
Special communication adapter	A generic term for FX3U-232ADP(-MB), FX3U-485ADP(-MB), and FX3U-ENET-ADP

*1 Area-specific model

1 Outline

1.1 Outline of the MELSEC iQ-F Series

Designed on the concepts of outstanding performance, superior drive control and user centric programming, Mitsubishi Electric MELSEC-F Series has been reborn as the MELSEC iQ-F Series.

From stand alone use to networked system applications, MELSEC iQ-F Series brings your business to the next level of industry.

Outstanding Performance

CPU Performance

A new sequence execution engine is at the core of MELSEC iQ-F, capable of running structured programs and multiple programs, and supports structured text and function blocks, etc.

High-speed System Bus Communication

The MELSEC iQ-F realizes high-speed CPU and high-speed system bus communication. This enables maximum performance even when using an intelligent function module with large amounts of data.

Security

MELSEC iQ-F has advanced security functions (file password, remote password, security key) to prevent data theft and illegal operations by unauthorized persons.

Superior Drive Control

Built-in Positioning

The MELSEC iQ-F features positioning functionality with CPU module built-in pulse output^{*1} and up to 8 axes of high-speed pulse input/output modules^{*2}. Positioning operations including interrupt, variable speed, and simple interpolation^{*2} can easily be set up in tables and executed.

*1 FX5UJ CPU module: Up to 3 axes

FX5S/FX5U/FX5UC CPU module: Up to 4 axes

*2 Only FX5U/FX5UC CPU module is supported.

Simple Motion Module

By connecting the Simple Motion module equipped with positioning function compatible with SSCNETⅢ/H, and combining linear interpolation, 2-axis circular interpolation, and continuous trajectory control in the program set by table method, a smooth trajectory can be easily drawn.

By starting with parameter settings and the PLC program, the Simple Motion modules can realize a variety of motion control including positioning control, advanced synchronous control, cam control and speed-torque control.

Predefined protocol support for positioning

Only by simply setting the system configuration, MELSEC iQ-F^{*1} and IAI ROBO Cylinder can be connected by MODBUS RTU connection to perform the positioning operation without considering transmission and reception of the communication command.

*1 Only FX5U/FX5UC CPU module is supported.

Improved Programming Environment

User-friendly Programming Software (GX Works3)

■System design with a convenient parts library

With GX Works3, designing a system is as easy as preparing the module configuration diagram by dragging and dropping selected parts.

■Auto-generation of module parameters

When preparing the module configuration diagram, simply double-click the module to automatically generate the module parameters. A window with an easy-to-use parameter settings screen opens, enabling module parameters to be modified as needed.

■Main programming languages supported

The main IEC languages are supported by GX Works3. Various different programming languages can be used within the same project simultaneously, and the labels and devices used in each program can be shared.

1.2 Substitute Models

The recommended substitute models (MELSEC iQ-F Series) introduced in this manual are general substitute models considered from the number of input/output points, program capacity, product and input/output terminal type (terminal block/connector etc.). According to usage and service condition, other substitute models different from those described may be suitable. Also, the recommended substitute models may no longer be appropriate due to factors such as the release of new products to the market and function improvements.

Please plan replacement to a substitute model with the following procedures.

Procedure to Replace to Substitute Model

1. Investigation of the existing system

List the installed places, number of units, and the type of PLCs. Investigate the programs and wiring diagram etc.

2. Diagnosis of the facilities

Make a diagnosis of the facility's importance and duration of service, usage environment etc., and set priorities and plan the replacement procedure.

3. Selection of the models

Select the replacement models according to the number of input/output points and the availability of extension modules etc. Select from the latest MELSEC iQ-F Series.

4. Reuse of the program

Consider either to reuse the program of the existing system, or create new program. When reusing, convert and correct the read out program to the new PLC's format.

5. Replacement of the models

Arrange the selected models and replace on-site.

6. Debug of the system

Test the system after replacement and adjust bugs and timing.

7. Completion

After debugging, migrate to live operation.

Selection and Replacement of the Models

The CPU modules and extension modules of FX3G/FX3U/FX3UC can be replaced by selecting models from the successor models FX5S/FX5UJ/FX5U/FX5UC that match the system.

Select models according to the following selection table.

Selection table

This selection table describes main performance specifications of the FX5.

For performance specifications, functions and external dimensions not described in the following table, refer to the relevant part in this manual or the user's manual of each module.

○: Supported, ×: Not supported

Item	Required functions	FX3G	FX3U	FX3UC	FX5S ^{*1}	FX5UJ ^{*2}	FX5U ^{*3}	FX5UC ^{*3}	Remarks
Power supply	AC power supply	○	○	×	○	○	○	×	—
	DC power supply	○	○	○	×	×	○	○	
Main unit output type	Relay	○	○	○	○	○	○	○	—
	Transistor	○	○	○	○	○	○	○	
Program memory capacity	48000 steps or less	○	○	○	○	○	○	○	Convert the project in GX Works3, and then check the number of program steps.
	More than 48000 steps	×	○	○	×	×	○	○	
Number of input/output points (Including remote I/O)	256 points or less	○	○	○	○	○	○	○	FX5S/FX5UJ: Using CC-Link IE Field Basic remote I/O enables a system configuration with 256 or more inputs and outputs. For details, refer to the CC-Link IE Field Network Basic Reference Manual .
	More than 256 points	×	○	○	×	×	○	○	
Clock function	—	○	○	○	○	○	○	○	<ul style="list-style-type: none"> FX5S/FX5UJ: The clock data is maintained (for 15 days) with the internal, large-capacity capacitor of the CPU module. If the voltage of the large-capacity capacitor drops, the clock data will not be maintained correctly. FX5U/FX5UC: The clock data is maintained (for 10 days) with the internal, large-capacity capacitor of the CPU module. When the optional battery is in use, operation is continued with the battery. <p>The FX5S, FX5UJ, FX5U, and FX5UC support a time setting function (an SNTP client). Check whether this function can be substituted. For details, refer to MELSEC iQ-F FX5 User's Manual (Ethernet Communication).</p>
Extension module	8 units or less	○	○	○	×	○	○	○	Extension modules cannot be connected to the FX5S.
	More than 8 units	×	○	○	×	×	○	○	
Serial communication channel	2 channels or less	○	○	○	○	○	○	○	FX5S/FX5UJ: These products have a built-in Ethernet port and USB port. Check whether the required serial communication function can be replaced with the built-in Ethernet or USB interface of the FX5S/FX5UJ.
	More than 2 channels	×	○	○	×	×	○	○	
Analog expansion adapter	2 units or less	○	○	○	×	○	○	○	FX5UJ: The intelligent function module for analog control can be used. If the number of analog expansion adapters is insufficient, check whether the situation can be handled with an FX5 intelligent function module.
	More than 2 units	×	○	○	○	×	○	○	

Item	Required functions	FX3G	FX3U	FX3UC	FX5S ^{*1}	FX5UJ ^{*2}	FX5U ^{*3}	FX5UC ^{*3}	Remarks
File registers (R devices)	With the battery keep function not in use	○	○	○	○	○	○	○	FX5S/FX5UJ: These products support an extension file register function. Check whether this function can be substituted. For details, refer to the MELSEC iQ-F FX5 User's Manual (Application).
	With the battery keep function in use	○	○	○	×	×	○	○	

*1 For details on replacing with the FX5S CPU module, refer to the following.

☞ Page 19 Replacement from FX3G to FX5S

*2 For details on replacing with the FX5UJ CPU module, refer to the following.

☞ Page 34 Replacement from FX3G to FX5UJ

☞ Page 49 Replacement from FX3U to FX5UJ

*3 For details on replacing with the FX5U/FX5UC CPU module, refer to the following.

☞ Page 63 Replacement from FX3U to FX5U

☞ Page 77 Replacement from FX3UC to FX5UC

2 Replacement from FX3G to FX5S

2.1 Outline

The FX5S is equipped with a built-in USB (Mini-B) connector and built-in Ethernet port as standard.

This module is compact and condenses the high basic performance, such as the positioning and IoT functions, and ease of use. This facilitates configuring user systems.

The procedures and points for replacing an existing model with the FX5S are shown below. Use this information to consider replacing existing models.

Points to Consider

- The "recommended substitute models" are described for individual FX3G and extension modules that can be replaced by MELSEC iQ-F Series models. According to usage and system configuration (connection status of the extension modules), and cases when the I/O numbers actually used are small, other models than the described "recommended substitute models" may be suitable for replacement.
- The recommended substitute models for items such as extension modules and function expansion boards are described with those that can be connected to the FX5S CPU module.
- Contents that require special caution when replacing each model are described in "Special notes". Most recommended substitute models have various differences in the specifications other than those in "Special notes" such as the dimensions becoming smaller than the current models. Therefore, when considering usage, please check not only the "Special notes" but also the details of various specifications such as the dimensions and power specifications in the manual.
- Based on the above conditions, "No recommended substitute models" is described for those without a recommended substitute model, but there are cases that can be replaced with an FX5S system configuration according to usage and system configuration. Check the necessary functions and features when considering the replacement with FX5S system configuration.

2.2 Replacement Procedure

The procedure for replacing the FX3G with the FX5S is shown below.

1. Selection of the models

Select the substitute models.

 Page 20 Selection of Substitute Models

2. Conversion of the program

Convert the program used in the FX3G to be able to use in the FX5S.

 Page 26 Conversion of the Projects

3. Replacement to the substitute models

Replace the PLCs.

 Page 33 Replacement of the PLC

2.3 Selection of Substitute Models

Recommended Substitute Models

Recommended Substitute Models for CPU Modules

The recommended substitute models of the FX5S compatible with the FX3G are introduced.

Please consider to replace the currently used CPU modules to the following recommended substitute models.

■List of recommended substitute models (CPU modules) for FX3G → FX5S replacement

FX3G Series		Recommended substitute models	Special notes
Device name	Model name	Model name	
CPU module	FX3G-14MR/ES	FX5S-30MR/ES	The number of I/O increases in the recommended substitute models.
	FX3G-14MT/ES	FX5S-30MT/ES	The number of I/O increases in the recommended substitute models.
	FX3G-14MT/ESS	FX5S-30MT/ESS	The number of I/O increases in the recommended substitute models.
	FX3G-24MR/ES	FX5S-30MR/ES	The number of I/O increases in the recommended substitute models.
	FX3G-24MT/ES	FX5S-30MT/ES	The number of I/O increases in the recommended substitute models.
	FX3G-24MT/ESS	FX5S-30MT/ESS	The number of I/O increases in the recommended substitute models.
	FX3G-40MR/ES	FX5S-40MR/ES	—
	FX3G-40MT/ES	FX5S-40MT/ES	—
	FX3G-40MT/ESS	FX5S-40MT/ESS	—
	FX3G-60MR/ES	FX5S-60MR/ES	—
	FX3G-60MT/ES	FX5S-60MT/ES	—
	FX3G-60MT/ESS	FX5S-60MT/ESS	—
	FX3G-14MR/DS	No recommended substitute models	—
	FX3G-14MT/DS	No recommended substitute models	—
	FX3G-14MT/DSS	No recommended substitute models	—
	FX3G-24MR/DS	No recommended substitute models	—
	FX3G-24MT/DS	No recommended substitute models	—
	FX3G-24MT/DSS	No recommended substitute models	—
	FX3G-40MR/DS	No recommended substitute models	—
	FX3G-40MT/DS	No recommended substitute models	—
	FX3G-40MT/DSS	No recommended substitute models	—
	FX3G-60MR/DS	No recommended substitute models	—
	FX3G-60MT/DS	No recommended substitute models	—
FX3G-60MT/DSS	No recommended substitute models	—	

Recommended Substitute Models for Extension Devices

The following list shows the extension devices that will be necessary to replace simultaneously when replacing the CPU module from FX3G to FX5S.

For products without a substitute model of the same function, check the contents described in the Special notes and please consider system reconfiguration.

■List of extension devices required to replace when replacing the CPU module from FX3G to FX5S

Extension device		Recommended substitute models	Special notes
Device name	Model name	Model name	
Extension I/O	FX2N-8ER	No recommended substitute models	Extension modules cannot be connected to the FX5S. If an extension module is needed, select the FX5UJ.
	FX2N-8ER-ES/UL	No recommended substitute models	
	FX2N-8EX	No recommended substitute models	
	FX2N-8EX-ES/UL	No recommended substitute models	
	FX2N-8EX-UA1/UL	No recommended substitute models	
	FX2N-16EX	No recommended substitute models	
	FX2N-16EX-ES/UL	No recommended substitute models	
	FX2N-16EX-C	No recommended substitute models	
	FX2N-16EXL-C	No recommended substitute models	
	FX2N-8EYR	No recommended substitute models	
	FX2N-8EYR-ES/UL	No recommended substitute models	
	FX2N-8EYR-S-ES/UL	No recommended substitute models	
	FX2N-8EYT	No recommended substitute models	
	FX2N-8EYT-ESS/UL	No recommended substitute models	
	FX2N-8EYT-H	No recommended substitute models	
	FX2N-16EYR	No recommended substitute models	
	FX2N-16EYR-ES/UL	No recommended substitute models	
	FX2N-16EYT	No recommended substitute models	
	FX2N-16EYT-ESS/UL	No recommended substitute models	
	FX2N-16EYT-C	No recommended substitute models	
	FX2N-16EYS	No recommended substitute models	
	FX2N-32ER	No recommended substitute models	
	FX2N-32ER-ES/UL	No recommended substitute models	
	FX2N-32ET	No recommended substitute models	
	FX2N-32ET-ESS/UL	No recommended substitute models	
	FX2N-32ES	No recommended substitute models	
	FX2N-48ER	No recommended substitute models	
	FX2N-48ER-ES/UL	No recommended substitute models	
	FX2N-48ET	No recommended substitute models	
	FX2N-48ET-ESS/UL	No recommended substitute models	
	FX2N-48ER-D	No recommended substitute models	
	FX2N-48ER-DS	No recommended substitute models	
	FX2N-48ET-D	No recommended substitute models	
FX2N-48ET-DSS	No recommended substitute models		
FX2N-48ER-UA1/UL	No recommended substitute models		

Extension device		Recommended substitute models	Special notes
Device name	Model name	Model name	
Extension device	FX3U-1PSU-5V	No recommended substitute models	Extension modules cannot be connected to the FX5S. If an extension module is needed, select the FX5UJ.
	FX3U-4AD	FX5-4AD-ADP	The wiring must be replaced from the screw terminal block to the European terminal block.
	FX3U-4DA	FX5-4DA-ADP	
	FX3U-4LC	No recommended substitute models	Extension modules cannot be connected to the FX5S. If an extension module is needed, select the FX5UJ.
	FX2N-2AD	FX5-4AD-ADP	The wiring must be replaced from the screw terminal block to the European terminal block.
	FX2N-2DA	FX5-4DA-ADP	
	FX2N-4AD	FX5-4AD-ADP	
	FX2N-4AD-TC	FX5-4AD-TC-ADP	
	FX2N-4AD-PT	FX5-4AD-PT-ADP	
	FX2N-4DA	FX5-4DA-ADP	
	FX2N-5A	FX5-4AD-ADP+FX5-4DA-ADP	
	FX2N-8AD	No recommended substitute models	
	FX2N-2LC	No recommended substitute models	Extension modules cannot be connected to the FX5S. If an extension module is needed, select the FX5UJ.
	FX2N-32CCL	No recommended substitute models	
	FX2N-64CL-M	No recommended substitute models	
	FX3U-16CCL-M	No recommended substitute models	
	FX3U-64CCL	No recommended substitute models	
	FX3U-128ASL-M	No recommended substitute models	
FX3U-32DP	No recommended substitute models		
Expansion board	FX3G-4EX-BD	No recommended substitute models	
	FX3G-2EYT-BD	No recommended substitute models	—
	FX3G-2AD-BD	No recommended substitute models	—
	FX3G-1DA-BD	No recommended substitute models	—
	FX3G-232-BD	FX5-232-BD	—
	FX3G-485-BD	FX5-485-BD	—
	FX3G-485-BD-RJ	FX5-485-BD	The wiring must be replaced from the RJ45 connector to the European terminal block.
	FX3G-422-BD	FX5-422-BD-GOT	GOT can only be connected to FX5-422-BD-GOT.
	FX3G-CNV-ADP	—	Not necessary for the FX5S CPU module.
	FX3G-8AV-BD	No recommended substitute models	—
	Expansion adapter	FX3U-232ADP(-MB)	FX5-232ADP
FX3U-485ADP(-MB)		FX5-485ADP	—
FX3U-ENET-ADP		No recommended substitute models	An Ethernet port is built into the FX5S CPU module.
FX3U-3A-ADP		FX5-4A-ADP	—
FX3U-4AD-ADP		FX5-4AD-ADP	—
FX3U-4DA-ADP		FX5-4DA-ADP	—
FX3U-4AD-PT-ADP		FX5-4AD-PT-ADP	—
FX3U-4AD-PTW-ADP		FX5-4AD-PT-ADP	—
FX3U-4AD-PNK-ADP		No recommended substitute models	—
FX3U-4AD-TC-ADP	FX5-4AD-TC-ADP	—	
Option	FX3G-EEPROM-32L	No recommended substitute models	Substituted by an SD memory card. If an SD memory card is used, the FX5-SDCD is required.
	FX3G-5DM	No recommended substitute models	—
	FX-30P	No recommended substitute models	—
	FX0N-30EC	No recommended substitute models	Not necessary for the FX5S because extension modules cannot be connected to it.
	FX0N-65EC	No recommended substitute models	
	FX2N-CNV-BC	No recommended substitute models	

Battery

The FX5S CPU module cannot use a battery.

The programs and devices of the FX5S CPU module are maintained in the built-in flash memory of the CPU.

Note that file registers (R) of the FX5S CPU module cannot be latched. (☞ Page 106 Device Replacement List)

The FX5S CPU module supports an extension file register function. For details, refer to the following.

📖 MELSEC iQ-F FX5 User's Manual (Application)

Precautions Regarding the Hardware

Comparison of the FX3G and FX5S and Precautions for Replacement

The following list shows precautions of the hardware. Check details in the manuals of each model when replacing existing models.

■Differences and precautions regarding the main hardware of the FX3G and FX5S

Item	Difference		Precautions
	FX3G	FX5UJ	
Extension of FX2N and FX3U	Extension possible	Extension not possible	—
Input hardware filter (When the digital filter is 0) • High-speed counter • Input interruption function • Pulse catch function	Approx. 10 ms X0 to X7 each has a built-in digital filter. The time can be changed to 0 to 15 ms with D8020. When this is set to 0, X0, X1, X3, and X4 are 10 μs and X2, X5, X6, and X7 are 50 μs.	■FX5S-30M□ X0, X1, X3, and X4: 5 μs or less when ON and 5 μs or less when OFF X2, X5, X6, and X7: 30 μs or less when ON and 50 μs or less when OFF X10 to X15: 50 μs or less when ON and 150 μs or less when OFF ■FX5S-40M□ and FX5S-60M□ X0, X1, X3, and X4: 5 μs or less when ON and 5 μs or less when OFF X2, X5, X6, and X7: 30 μs or less when ON and 50 μs or less when OFF X10 to X17: 50 μs or less when ON and 150 μs or less when OFF X20 or later: Approx. 10 ms when ON and approx. 10 ms when OFF	Noises that were not detected by FX3G may possibly be captured as an input. Take external measures against noise, or set an appropriate input response time parameter.
Input signal current	X0 to X7: 7 mA X10 or later: 5 mA	X0 to X7: 5.1 mA X10 or later: 4 mA	The input signal current has been lowered, so it is necessary to check the specification of the external devices when replacing.

■External dimension drawing

There are some differences in the external dimensions of the FX3G and FX5S. Be careful when replacing the modules.

- FX3G

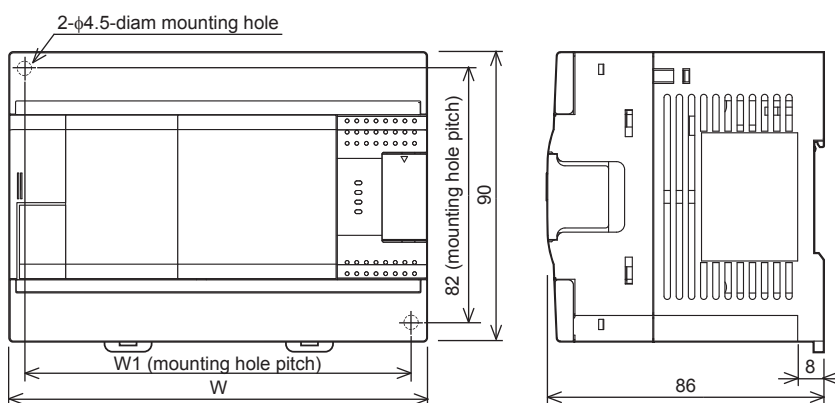

External color: Munsell 0.08GY/7.64/0.81
 Top cover: Munsell N1.5
 Unit: mm
 The terminal block uses M3 terminal screws
 35 mm width DIN rail can be installed

Model name	W: mm	W1: mm	Weight: kg
FX3G-14M□	90	82	Approx. 0.50
FX3G-24M□	90	82	Approx. 0.55
FX3G-40M□	130	122	Approx. 0.70
FX3G-60M□	175	167	Approx. 0.85

• FX5S

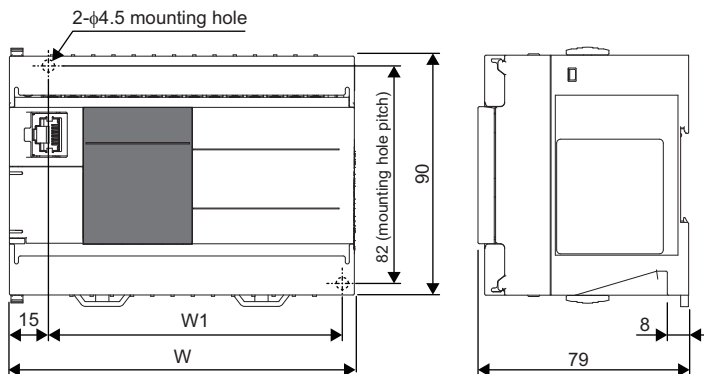

External color: Munsell 0.6B7.6/0.2
 Unit: mm
 The terminal block uses M3 terminal screws.
 A 35-mm width DIN rail can be installed.

Model name	W: mm	W1: mm	Weight: kg
FX5S-30M□	100	81	Approx. 0.45
FX5S-40M□	130	111	Approx. 0.55
FX5S-60M□	175	156	Approx. 0.65

■ Cable sizes for European type terminal block

Suitable wiring and tightening torque are described below.

	Wire size for one wire	Wire size for two wires	Wire ferrule with insulation sleeve (wire size)	Tightening torque	Stripping dimensions of electric wire ends
FX3G-485-BD, FX3U-485ADP(-MB) FX5-485-BD, FX5-485ADP	AWG22 to AWG20	AWG22	AWG22 to AWG20	0.22 to 0.25 N·m	9 mm
FX5-4AD-ADP, FX5-4DA-ADP, FX5-4A-ADP, FX5-4AD-PT-ADP, FX5-4AD-TC-ADP				0.20 N·m	

■ Differences and precautions regarding installing the FX3G and FX5S

The pitch of the holes for installation in a control panel differs between the FX3G and FX5S. When making a direct installation in a control panel, installation holes must be added. Also, because the terminal block shapes differ, one terminal block cannot be replaced with the other. (☞ Page 24 External dimension drawing)

■ Differences and precautions regarding the drive power supply of the output section of the FX3G and FX5S

- Output section power supply voltage consolidation

When replacing the FX3G with the FX5S, the power supplies must be consolidated if a separate power supply has been installed with one output common terminal of the FX3G.

- Maximum output load current

When the FX3G is replaced with the FX5S, the maximum load current of part of the output section changes.

For Y0 to Y3 on the FX3G-24M□, one common terminal is used per output, but this changes to one common terminal for four outputs for Y0 to Y3 on the FX5S-30M□.

If separate power supplies have been installed with each common terminal, consolidate the power supplies.

(Example) FX3G-24MT/ES (output side)

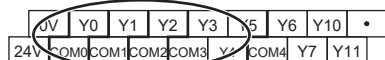

- <Maximum output load current>
- Maximum load (resistance load) current of 1 output common terminal: 0.5 A or less

(Example) FX5S-30MT/ES (output side)

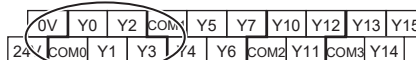

- <Maximum output load current>
- Maximum load (resistance load) current of 1 output common terminal: 0.5 A or less
 - Maximum load (resistance load) current of 3 output common terminal: 0.6 A or less
 - Maximum load (resistance load) current of 4 output common terminal: 0.8 A or less

2.4 Conversion of the Projects

When converting FX3G projects to FX5S projects, use GX Works3.

After converting the projects, it may be necessary to adjust the programs (instructions, devices) and parameters.

Operation Method for Replacing Projects

To convert FX3G projects to FX5S projects, perform operations in GX Works3.

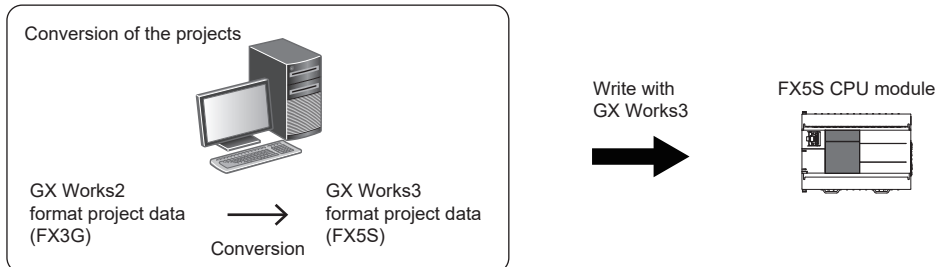

To convert the projects, install the engineering tool of the following version.

Engineering tool	Version	Remarks
GX Works3	1.080J or higher	—
GX Works2	1.519R or higher	Supplied with GX Works3.

Precautions

- To read projects of GX Works2 using GX Works3, convert beforehand using GX Works2, and then read the projects. Even for projects converted using GX Works2, conversion may not be performed according to the state of the project. If there is an error in the program, operation will be canceled.
- To read projects of GX Works2 using GX Works3, delete the security (user Management, data security setting) of GX Works2 beforehand and then read the projects. If the security is set to the GX Works2 project, read out will be canceled.
- To read projects of GX Works2 using GX Works3, administrator rights are required.
- The FX5S does not support the SFC program.

Operating procedure

1. Start up GX Works3.
 2. Open the FX3G project.
- ① Select [Project] ⇒ [Open Other Format File] ⇒ [GX Works2 Format] ⇒ [Open Project] ⇒ Project (*.gwx).

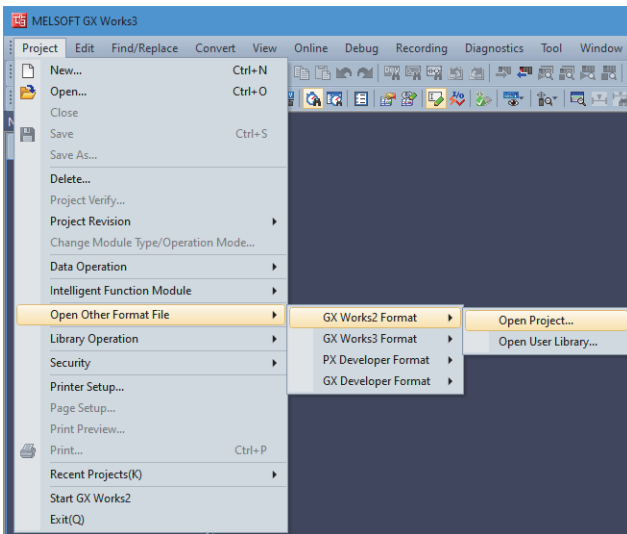

3. The following display is shown.
A selection screen of the following new module type is shown.
Select the new module type and press the [Execute] button.

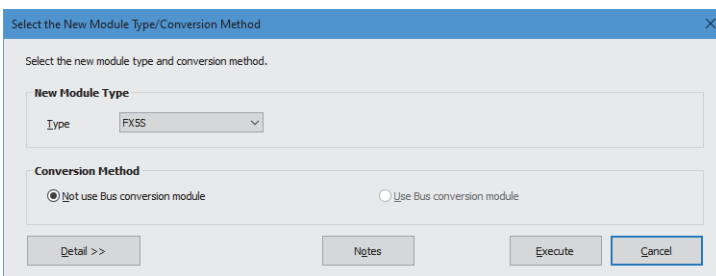

4. When conversion is completed, the following message is shown.

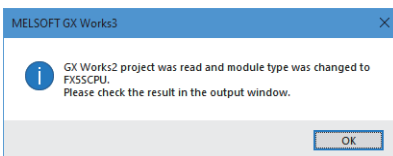

5. Check the contents of the model change result in the “Output window”.

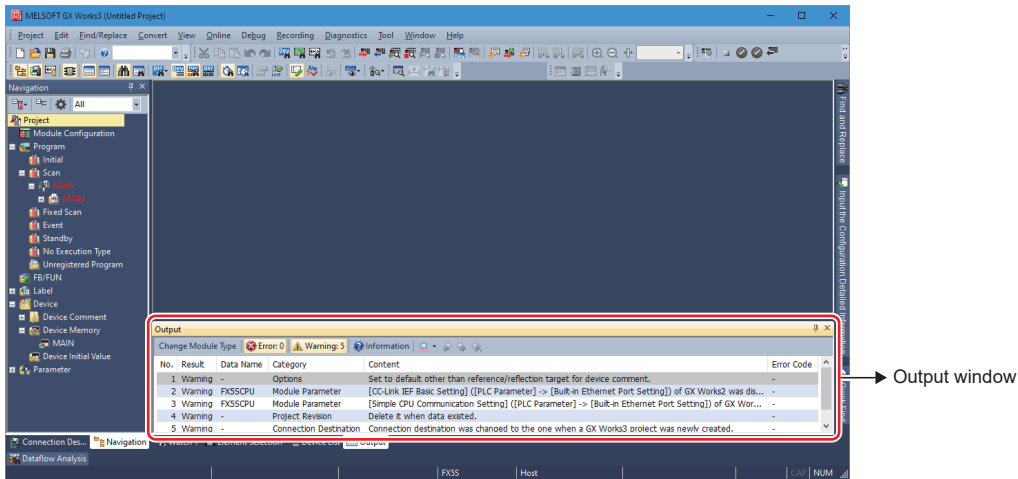

Precautions

- When projects are converted, the program instructions and devices may be changed. Check the contents of the project. Parameters other than the CC-Link network parameters*¹ will be deleted. Set the parameters if necessary.

*¹ For details on CC-Link network parameters, refer to Page 29 Precautions when Replacing the Parameters.

6. Set the model name of the CPU for the system parameter.

[System Parameter] ⇒ [I/O Assignment Setting] ⇒ Model Name

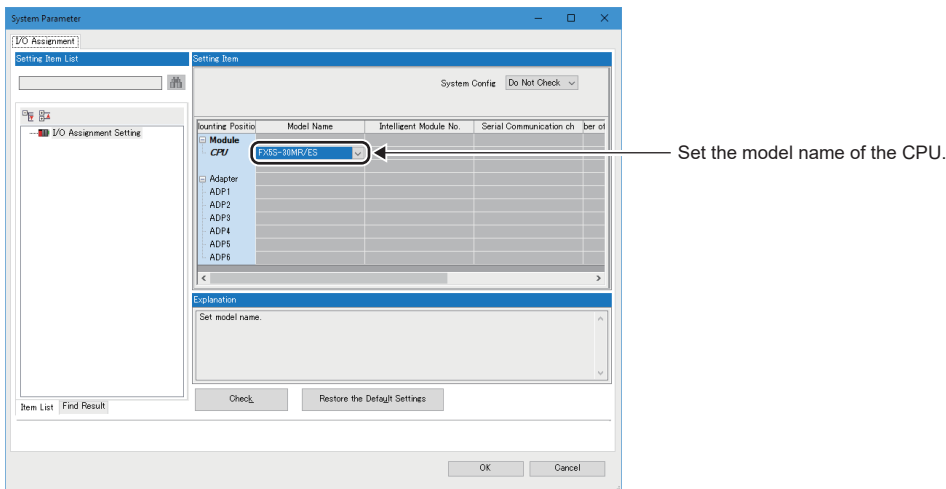

7. Perform conversion.

[Convert] ⇒ [Rebuild All]

Precautions when Converting the Projects

- When converting FX3G projects using GX Works3, be careful because the program (instructions and devices) may be changed.
- When converting projects, the number of steps may increase and writing to the FX5S may be impossible. Check the number of steps after replacement.
- Characters used for the label name in GX Works2 may correspond to reserved words or illegal characters in GX Works3. In that case, change the label name.

For precautions regarding instruction and device conversion, refer to  Page 92 Instruction Replacement List.

Precautions when Replacing the Parameters

When converting FX3G projects to FX5S projects, the setting data of the parameters (PC parameters and network parameters) and special modules (intelligent function modules) will be deleted. Therefore, it is necessary to set the data with GX Works3 again.

Also, GX Works3 does not support the following parameters of the FX3G, so it is necessary to set these parameters with GX Works3 again.

- Network parameters (CC-Link)
- Intelligent function module parameter (AnyWireASLINK)

Precautions when Replacing Other Functions

Precautions when Using the High-speed Counters

When the high-speed counters (C235 to C255) are used with the FX3G, they will not operate just by switching to the FX5S. It is necessary to set the FX3 Series compatible high-speed counters and change the program by the parameter. For the setting procedure, refer to the following.

■Parameter Setting Procedure of the FX3 Series Compatible High-speed Counters

1. Select "Long Counter Specification" at the specification for High-speed counters.

 [Parameter] ⇒ [FX5SCPU] ⇒ [Module Parameter] ⇒ [High Speed I/O] ⇒ "Input Function" ⇒ "High Speed Counter" ⇒ "Detailed Setting" ⇒ "Other"

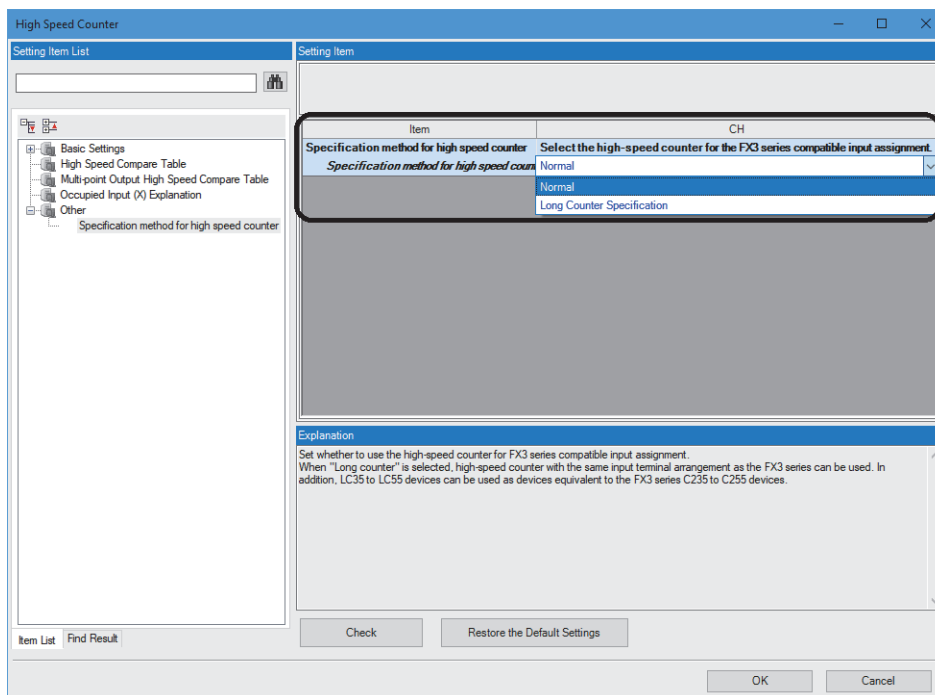

2. Set the function of the high-speed counters used with the FX3G.

Select the input comparison enable/disable of the counter device and preset input compatible with the FX3 Series, and select the control switch.

Item	CH1	CH2	CH3
Use/Do Not Use Counter	Set whether to use counter or not.		
Use/Not Use	Use	Not Use	Not Use
Counter device	Select the high-speed counter for the FX3 series compatible input assignment.		
Counter device	LC35 (Operation equivalent to C235)	LC36 (Operation equivalent to C236)	LC37 (Operation equivalent to C237)
Operation Mode	Set operation mode.		
Operation Mode	Normal Mode	Normal Mode	Normal Mode
Pulse Input Mode	Set pulse input mode.		
Pulse Input Mode	1-Phase 1 Input (S/W Up/Down Switch)	1-Phase 1 Input (S/W Up/Down Switch)	1-Phase 1 Input (S/W Up/Down Switch)
Preset Input	Set preset input.		
Preset Input Enable/Disable	Disable	Disable	Disable
Input logic	Positive Logic	Positive Logic	Positive Logic
Preset Value	0	0	0
Input Comparison Enable/Disable	Enable		
Control Switch	Rising	Rising	Rising
Enable Input	Set enable input.		
Enable Input Enable/Disable	Disable	Disable	Disable
Input logic	Positive Logic	Positive Logic	Positive Logic
Ring Length Setting	Set ring length.		
Ring Length Enable/Disable	Disable	Disable	Disable
Ring Length	2147483648	2147483648	2147483648
Measurement Unit Time	Set the measurement unit time (ms) for the pulse density measurement mode and rotation speed measurement mode.		
Measurement Unit Time	1000 ms	1000 ms	1000 ms
Number of Pulses per Rotation	Set the number of pulses per rotation when using the rotation speed measurement mode.		
Number of Pulses per Rotation	1000 pulse	1000 pulse	1000 pulse

■ Changing the Program

Change the high-speed counter program by referring to the following program example.

[Example of program]

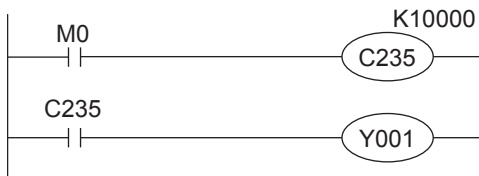

↓ Change the program.

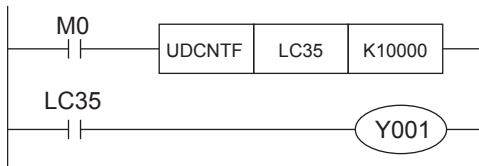

Precautions when Using the Routine Timer

When the routine timer (T192 to T199) is used with the FX3G, they will not operate just by switching to the FX5S. The routine timer must be set by the parameter. For the setting procedure, refer to the following.

Parameter Setting Procedure of the Routine Timer

Set the use of the routine timer and the leading device number.

[Parameter] ⇒ [FX5SCPU] ⇒ [CPU Parameter] ⇒ "Memory/Device Setting" ⇒ "Memory/Device Setting"

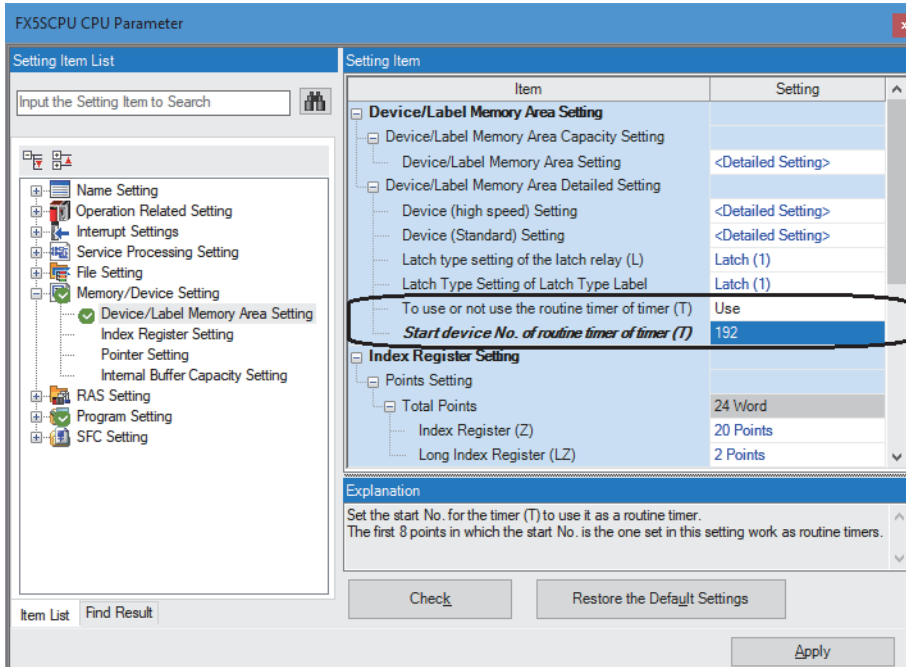

Serial Communication Channel Assignment (RS-485, RS-232C)

When the FX3G is replaced with the FX5S, the communication channel assignments that can be used change. Change the communication channels specified with instructions and parameter settings so that these channels match the specifications.

FX3G communication channel assignment

- FX3G-14M□ and FX3G-24M□

A communication function expansion board and a special communication adapter can be used to connect up to one channel of serial ports.

The configurable combinations are shown below.

[Configuration example 1]

Using a special communication adapter

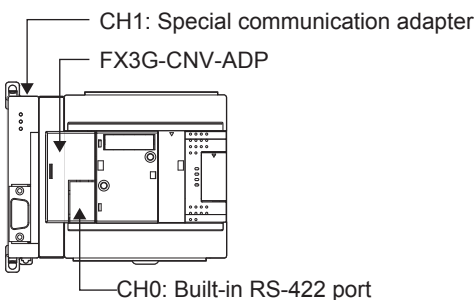

[Configuration example 2]

Using a communication function expansion board

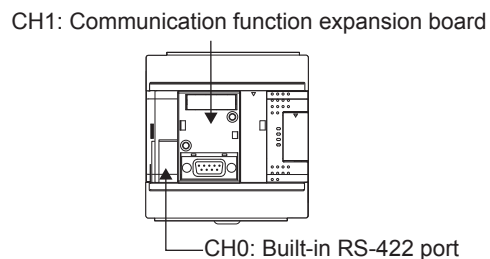

- FX3G-40M□ and FX3G-60M□

A communication function expansion board and a special communication adapter can be used to connect up to two channels of serial ports.

The configurable combinations are shown below.

[Configuration example 1]

Using a communication function expansion board and a special communication adapter at the same time

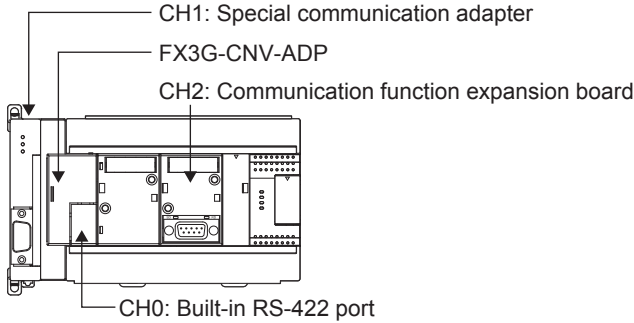

[Configuration example 2]

Using two special communication adapters

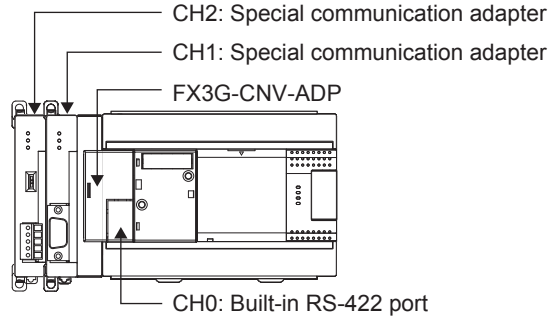

■FX5S communication channel assignment

A communication board and a communication adapter can be used to connect up to two channels of serial ports.

The communication channel assignments are fixed regardless of the system configuration.

The configurable combinations are shown below.

[Configuration example 1]

Using a communication board and a communication adapter at the same time

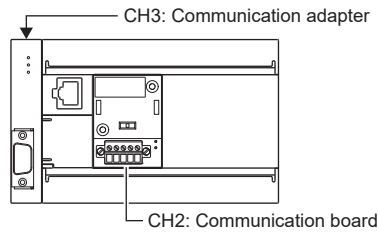

[Configuration example 2]

Using two communication adapters

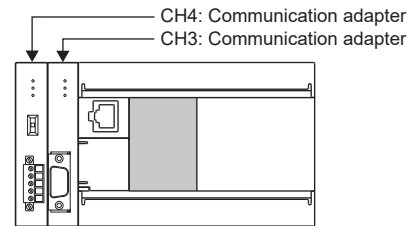

Ex.

When two special communication adapters connected to the FX3G are replaced with two FX5S communication adapters, the communication channels change from CH1 and CH2 to CH3 and CH4.

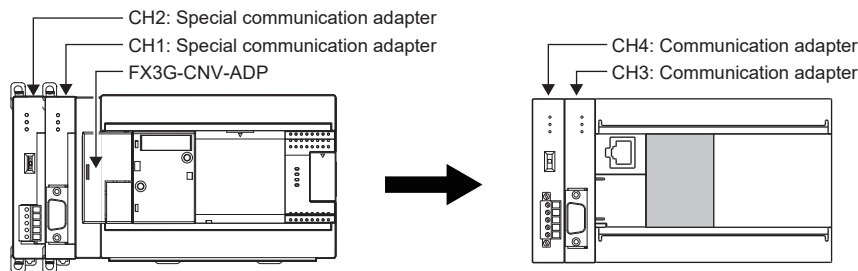

2.5 Replacement of the PLC

The main points to consider during replacement of the CPU module and extension modules are explained below.

For details of each item, check the reference pages in this document, and related manuals such as the PLC Hardware Manual and Programming Manual.

Device classification	Item	Operation content and points of attention	Reference page
CPU module	Reuse of the input/output wiring	Perform rewiring for the connection part of the terminal block type.	☞ Page 20
Other extension modules	Wiring to each module		
Verifying operation of the equipment	Operation and test of the PLC program	Operate the converted PLC program and hardware devices, and check and adjust the device function and operation timing. Be aware of the precautions described on the reference page for replacing the project, and check that the devices operate as they are designed.	☞ Page 26

3 Replacement from FX3G to FX5UJ

3.1 Outline

The FX5UJ is equipped with communication, high-speed input/output, etc. and can easily be expanded with expansion boards and expansion adapters. Up to eight I/O modules and FX5 intelligent function modules (combined) can be connected.

The procedures and points for replacing an existing model with the FX5UJ are shown below. Use this information to consider replacing existing models.

Points to Consider

- The “recommended substitute models” are described for individual FX3G and extension modules that can be replaced by iQ-F Series models. According to usage and system configuration (connection status of the extension modules), and cases when the I/O numbers actually used are small, other models than the described “recommended substitute models” may be suitable for replacement.
- The recommended substitute models for items such as extension modules and function expansion boards are described with those that can be connected to the FX5UJ CPU module.
- Contents that require special caution when replacing each model are described in “Special notes”. Most recommended substitute models have various differences in the specifications other than those in “Special notes” such as the dimensions becoming smaller than the current models. Therefore, when considering usage, please check not only the “Special notes” but also the details of various specifications such as the dimensions and power specifications in the manual.
- Based on the above conditions, “No recommended substitute models” is described for those without a recommended substitute model, but there are cases that can be replaced with an FX5UJ system configuration according to usage and system configuration. Check the necessary functions and features when considering the replacement with FX5UJ system configuration.

3.2 Replacement Procedure

The procedure for replacing the FX3G with the FX5UJ is shown below.

1. Selection of the models

Select the substitute models.

 Page 35 Selection of Substitute Models

2. Conversion of the program

Convert the program used in FX3G to be able to use in FX5UJ.

 Page 41 Conversion of the Projects

3. Replacement to the substitute models

Replace the PLCs.

 Page 48 Replacement of the PLC

3.3 Selection of Substitute Models

Recommended Substitute Models

Recommended Substitute Models for CPU Modules

The recommended substitute models of the FX5UJ compatible with the FX3G are introduced below.

Please consider to replace the currently used CPU modules to the following recommended substitute models.

■List of recommended substitute models (CPU modules) for FX3G → FX5UJ replacement

FX3G Series		Recommended substitute models	Special notes
Device name	Model name	Model name	
CPU module	FX3G-14MR/ES	FX5UJ-24MR/ES	The number of I/O increases in the recommended substitute models.
	FX3G-14MT/ES	FX5UJ-24MT/ES	The number of I/O increases in the recommended substitute models.
	FX3G-14MT/ESS	FX5UJ-24MT/ESS	The number of I/O increases in the recommended substitute models.
	FX3G-24MR/ES	FX5UJ-24MR/ES	—
	FX3G-24MT/ES	FX5UJ-24MT/ES	—
	FX3G-24MT/ESS	FX5UJ-24MT/ESS	—
	FX3G-40MR/ES	FX5UJ-40MR/ES	—
	FX3G-40MT/ES	FX5UJ-40MT/ES	—
	FX3G-40MT/ESS	FX5UJ-40MT/ESS	—
	FX3G-60MR/ES	FX5UJ-60MR/ES	—
	FX3G-60MT/ES	FX5UJ-60MT/ES	—
	FX3G-60MT/ESS	FX5UJ-60MT/ESS	—
	FX3G-14MR/DS	No recommended substitute models	—
	FX3G-14MT/DS	No recommended substitute models	—
	FX3G-14MT/DSS	No recommended substitute models	—
	FX3G-24MR/DS	No recommended substitute models	—
	FX3G-24MT/DS	No recommended substitute models	—
	FX3G-24MT/DSS	No recommended substitute models	—
	FX3G-40MR/DS	No recommended substitute models	—
	FX3G-40MT/DS	No recommended substitute models	—
	FX3G-40MT/DSS	No recommended substitute models	—
	FX3G-60MR/DS	No recommended substitute models	—
	FX3G-60MT/DS	No recommended substitute models	—
	FX3G-60MT/DSS	No recommended substitute models	—

Recommended Substitute Models for Extension Devices

The following list shows the extension devices that will be necessary to replace simultaneously when replacing the CPU module from FX3G to FX5UJ.

For products without a substitute model of the same function, check the contents described in the Special notes and please consider system reconfiguration.

■List of extension devices required to replace when replacing the CPU module from FX3G to FX5UJ

Extension device		Recommended substitute models	Special notes
Device name	Model name	Model name	
Extension I/O	FX2N-8ER	FX5-16ER/ES	The number of I/O increases in the recommended substitute models.
	FX2N-8ER-ES/UL	FX5-16ER/ES	The number of I/O increases in the recommended substitute models.
	FX2N-8EX	FX5-8EX/ES	
	FX2N-8EX-ES/UL	FX5-8EX/ES	
	FX2N-8EX-UA1/UL	No recommended substitute models	
	FX2N-16EX	FX5-16EX/ES	
	FX2N-16EX-ES/UL	FX5-16EX/ES	
	FX2N-16EX-C	FX5-CNV-IF+FX5-C16EX/D	Only a connector type module can be connected after (on the right side of) FX5-CNV-IF.
	FX2N-16EXL-C	No recommended substitute models	
	FX2N-8EYR	FX5-8EYR/ES	
	FX2N-8EYR-ES/UL	FX5-8EYR/ES	
	FX2N-8EYR-S-ES/UL	No recommended substitute models	
	FX2N-8EYT	FX5-8EYT/ES	
	FX2N-8EYT-ESS/UL	FX5-8EYT/ESS	
	FX2N-8EYT-H	No recommended substitute models	
	FX2N-16EYR	FX5-16EYR/ES	
	FX2N-16EYR-ES/UL	FX5-16EYR/ES	
	FX2N-16EYT	FX5-16EYT/ES	
	FX2N-16EYT-ESS/UL	FX5-16EYT/ESS	
	FX2N-16EYT-C	FX5-CNV-IF+FX5-C16EYT/D	Only a connector type module can be connected after (on the right side of) FX5-CNV-IF.
	FX2N-16EYS	No recommended substitute models	
	FX2N-32ER	FX5-32ER/ES	
	FX2N-32ER-ES/UL	FX5-32ER/ES	
	FX2N-32ET	FX5-32ET/ES	
	FX2N-32ET-ESS/UL	FX5-32ET/ESS	
	FX2N-32ES	No recommended substitute models	
	FX2N-48ER	FX5-32ER/ES+FX5-16ER/ES	
	FX2N-48ER-ES/UL	FX5-32ER/ES+FX5-16ER/ES	
	FX2N-48ET	FX5-32ET/ES+FX5-16ET/ES	
	FX2N-48ET-ESS/UL	FX5-32ET/ESS+FX5-16ET/ESS	
	FX2N-48ER-D	No recommended substitute models	
	FX2N-48ER-DS	No recommended substitute models	
FX2N-48ET-D	No recommended substitute models		
FX2N-48ET-DSS	No recommended substitute models		
FX2N-48ER-UA1/UL	No recommended substitute models		

Extension device		Recommended substitute models	Special notes
Device name	Model name	Model name	
Extension device	FX3U-1PSU-5V	FX5-1PSU-5V	
	FX3U-4AD	FX5-4AD	The wiring must be replaced from the screw terminal block to the European terminal block.
	FX3U-4DA	FX5-4DA	
	FX3U-4LC	FX5-4LC	
	FX2N-2AD	FX5-4AD	
	FX2N-2DA	FX5-4DA	
	FX2N-4AD	FX5-4AD	
	FX2N-4AD-TC	FX5-4AD-TC-ADP	
	FX2N-4AD-PT	FX5-4AD-PT-ADP	
	FX2N-4DA	FX5-4DA	
	FX2N-5A	FX5-4AD+FX5-4DA	
	FX2N-8AD	FX5-8AD	
	FX2N-2LC	FX5-4LC	
	FX2N-32CCL	FX5-CCL-MS	
	FX2N-64CL-M	No recommended substitute models	
	FX3U-CAN	No recommended substitute models	
	FX3U-J1939	No recommended substitute models	
	FX3U-16CCL-M	FX5-CCL-MS	Set to the master station in the recommended substitute models.
	FX3U-64CCL	FX5-CCL-MS	Set to the intelligent device station in the recommended substitute models.*1
	FX3U-128ASL-M	FX5-ASL-M	
FX3U-32DP	No recommended substitute models		
Expansion board	FX3G-4EX-BD	No recommended substitute models	
	FX3G-2EYT-BD	No recommended substitute models	
	FX3G-2AD-BD	No recommended substitute models	
	FX3G-1DA-BD	No recommended substitute models	
	FX3G-232-BD	FX5-232-BD	
	FX3G-485-BD	FX5-485-BD	
	FX3G-485-BD-RJ	FX5-485-BD	The wiring must be replaced from the RJ45 connector to the European terminal block.
	FX3G-422-BD	FX5-422-BD-GOT	GOT can only be connected to FX5-422-BD-GOT.
	FX3G-CNV-ADP	—	Not necessary for FX5UJ CPU module.
	FX3G-8AV-BD	No recommended substitute models	
Expansion adapter	FX3U-232ADP(-MB)	FX5-232ADP	
	FX3U-485ADP(-MB)	FX5-485ADP	
	FX3U-ENET-ADP	No recommended substitute models	Ethernet port is built into FX5UJ CPU module.
	FX3U-3A-ADP	FX5-4A-ADP	
	FX3U-4AD-ADP	FX5-4AD-ADP	
	FX3U-4DA-ADP	FX5-4DA-ADP	
	FX3U-4AD-PT-ADP	FX5-4AD-PT-ADP	
	FX3U-4AD-PTW-ADP	FX5-4AD-PT-ADP	
	FX3U-4AD-PNK-ADP	No recommended substitute models	
	FX3U-4AD-TC-ADP	FX5-4AD-TC-ADP	
Option	FX3G-EEPROM-32L	No recommended substitute models	Substituted by an SD memory card.
	FX3G-5DM	No recommended substitute models	
	FX-30P	No recommended substitute models	
	FX0N-30EC	FX5-30EC	
	FX0N-65EC	FX5-65EC	
	FX2N-CNV-BC	FX5-CNV-BC	

*1 FX5-CCL-MS can be used as a master station.

Extension devices that can be reused when the CPU module is replaced to FX5UJ

The following extension devices can be used even when the CPU module is replaced (FX3G → FX5UJ).

■ Extension devices that can be used even when the CPU module is replaced from the FX3G to FX5UJ

Terminal module

FX-16E-TB, FX-32E-TB, FX-16EX-A1-TB, FX-16EYR-TB, FX16EYS-TB, FX-16EYT-TB

FX-16E-TB/UL, FX-32E-TB/UL, FX-16EYR-ES-TB/UL, FX-16EYS-ES-TB/UL, FX-16EYT-ES-TB/UL, FX-16EYT-ESS-TB/UL

Battery

The FX5UJ CPU module cannot use a battery. However, the programs and devices of the FX5UJ CPU module are maintained in the built-in flash memory of the CPU.

Note that file registers (R) of the FX5UJ CPU module cannot be latched. (☞ Page 106 Device Replacement List)

Precautions Regarding the Hardware

Comparison of FX3G and FX5UJ and Precautions for Replacement

The following list shows precautions of the hardware. Check details in the manuals of each model when replacing existing models.

■Difference and precautions regarding the main hardware of FX3G and FX5UJ

Item	Difference		Precautions
	FX3G	FX5UJ	
Extension of FX2N and FX3U	Extension possible	Extension not possible	—
Input hardware filter (When the digital filter is 0) • High-speed counter • Input interruption function • Pulse catch function	Approx. 10 ms X0 to X7 each has a built-in digital filter. The time can be changed to 0 to 15 ms with D8020. When this is set to 0, X0, X1, X3, and X4 are 10 μs and X2, X5, X6, and X7 are 50 μs.	■FX5UJ-24M□ X0, X1, X3, and X4: 5 μs or less when ON and 5 μs or less when OFF X2, X5, X6, and X7: 30 μs or less when ON and 50 μs or less when OFF X10 to X15: 50 μs or less when ON and 150 μs or less when OFF ■FX5UJ-40M□ and FX5UJ-60M□ X0, X1, X3, and X4: 5 μs or less when ON and 5 μs or less when OFF X2, X5, X6, and X7: 30 μs or less when ON and 50 μs or less when OFF X10 to X17: 50 μs or less when ON and 150 μs or less when OFF X20 or later: Approx. 10 ms when ON and approx. 10 ms when OFF	Noises that were not detected by FX3G may possibly be captured as an input. Take external measures against noise, or set an appropriate input response time parameter.
Input signal current	X0 to X7: 7 mA X10 or later: 5 mA	X0 to X7: 5.3 mA X10 or later: 4 mA	The input signal current has been lowered, so it is necessary to check the specification of the external devices when replacing.

■External dimension drawing

There are some differences in the external dimensions of the FX3G and the FX5UJ. Be careful when replacing the modules.

• FX3G

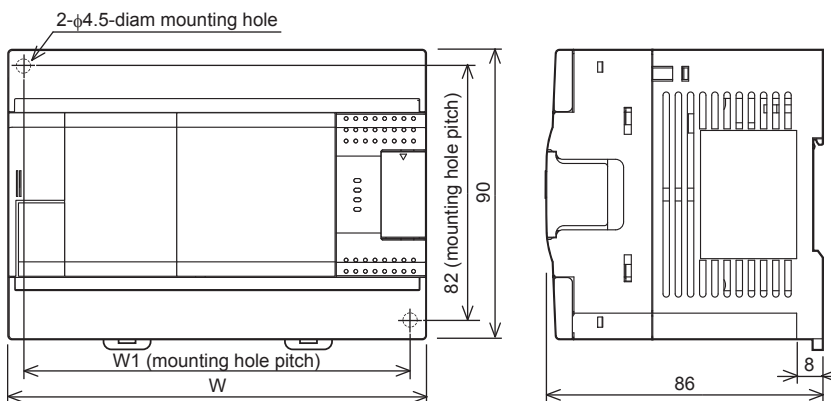

External color: Munsell 0.08GY/7.64/0.81
 Top cover: Munsell N1.5
 Unit: mm
 The terminal block uses M3 terminal screws
 35 mm width DIN rail can be installed

Model name	W: mm	W1: mm	Weight: kg
FX3G-14M□	90	82	Approx. 0.50
FX3G-24M□	90	82	Approx. 0.55
FX3G-40M□	130	122	Approx. 0.70
FX3G-60M□	175	167	Approx. 0.85

• FX5UJ

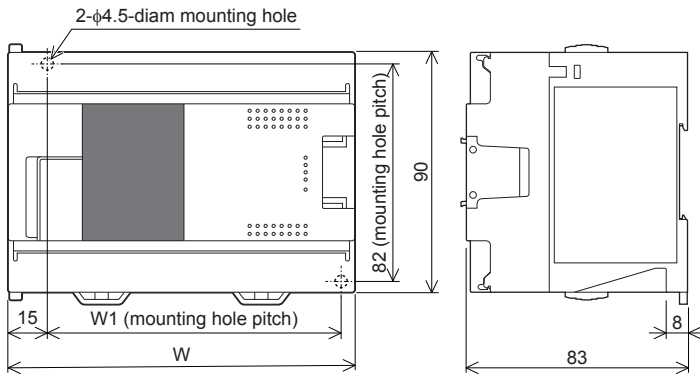

External color: Munsell 0.6B7.6/0.2
 Unit: mm
 The terminal block uses M3 terminal screws
 35 mm width DIN rail can be installed

Model name	W: mm	W1: mm	Weight: kg
FX5UJ-24M□	95	76	Approx. 0.55
FX5UJ-40M□	130	111	Approx. 0.65
FX5UJ-60M□	175	156	Approx. 0.80

■Cable sizes for European type terminal block

Suitable wiring and tightening torque are described below.

	Wire size for one wire	Wire size for two wires	Wire ferrule with insulation sleeve (wire size)	Tightening torque	Stripping dimensions of electric wire ends
FX3G-485-BD, FX3U-485ADP(-MB) FX5-485-BD, FX5-485ADP	AWG22 to AWG20	AWG22	AWG22 to AWG20	0.22 to 0.25 N·m	9 mm
FX5-4AD-ADP, FX5-4DA-ADP, FX5-4A-ADP, FX5-4AD-PT-ADP, FX5-4AD-TC-ADP				0.20 N·m	

■Differences and precautions regarding installing the FX3G and FX5UJ

The pitch of the holes for installation in a control panel differs between the FX3G and FX5UJ. When making a direct installation in a control panel, installation holes must be added. Also, because the terminal block shapes differ, one terminal block cannot be replaced with the other. (☞ Page 39 External dimension drawing)

■Differences and precautions regarding the drive power supply of the output section of the FX3G and FX5UJ

- Output section power supply voltage consolidation

When replacing the FX3G with the FX5UJ, the power supplies must be consolidated if a separate power supply has been installed with one output common terminal of the FX3G.

- Maximum output load current

When the FX3G is replaced with the FX5UJ, the maximum load current of part of the output section changes.

For Y0 to Y2 on the FX3G-24M□, one common terminal is used per output, but this changes to one common terminal for three outputs in the case of Y0 to Y2 on the FX5UJ-24M□.

If separate power supplies have been installed with each common terminal, consolidate the power supplies.

(Example) FX3G-24MT/ES (output side)

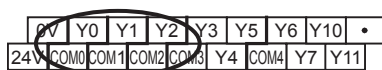

<Maximum output load current>

- Maximum load (resistance load) current of 1 output common terminal: 0.5 A or less

(Example) FX5UJ-24MT/ES (output side)

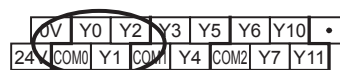

<Maximum output load current>

- Maximum load (resistance load) current of 1 output common terminal: 0.5 A or less
- Maximum load (resistance load) current of 3 output common terminal: 0.6 A or less
- Maximum load (resistance load) current of 4 output common terminal: 0.8 A or less

3.4 Conversion of the Projects

When converting FX3G projects to FX5UJ projects, use GX Works3.

After converting the projects, it may be necessary to adjust the programs (instructions, devices) and parameters.

Operation Method for Replacing Projects

To convert FX3G projects to FX5UJ projects, perform operations in GX Works3.

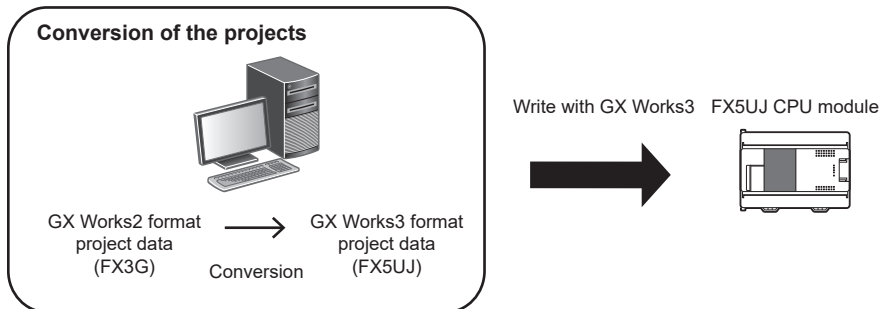

To convert the projects, install the engineering tool of the following version.

Engineering tool	Version	Remarks
GX Works3	1.065T or higher*1	—
GX Works2	1.519R or higher	Supplied with GX Works3.

*1 For GX Works3 version 1.063R and earlier, it is necessary to read FX5U projects beforehand and convert the projects to FX5UJ projects with model/operation mode change.

Precautions

- To read projects of GX Works2 using GX Works3, convert beforehand using GX Works2, and then read the projects. Even for projects converted using GX Works2, conversion may not be performed according to the state of the project. If there is an error in the program, operation will be canceled.
- To read projects of GX Works2 using GX Works3, delete the security (user Management, data security setting) of GX Works2 beforehand and then read the projects. If the security is set to the GX Works2 project, read out will be canceled.
- To read projects of GX Works2 using GX Works3, administrator rights are required.
- FX5UJ does not support the SFC program.

Operating procedure

1. Start up GX Works3.
2. Open the FX3G project.

Select [Project] ⇒ [Open Other Format File] ⇒ [GX Works2 Format] ⇒ [Open Project] ⇒ Project (***.gxw).

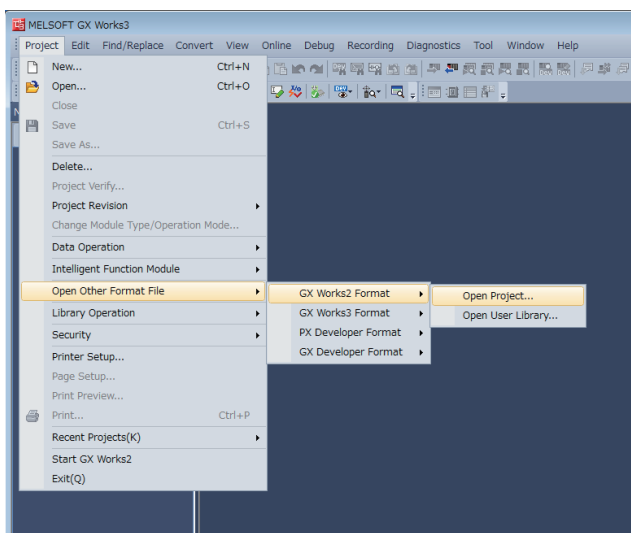

3. The following display is shown.

A selection screen of the following new module type is shown.

Select the new module type and press the [Execute] button.

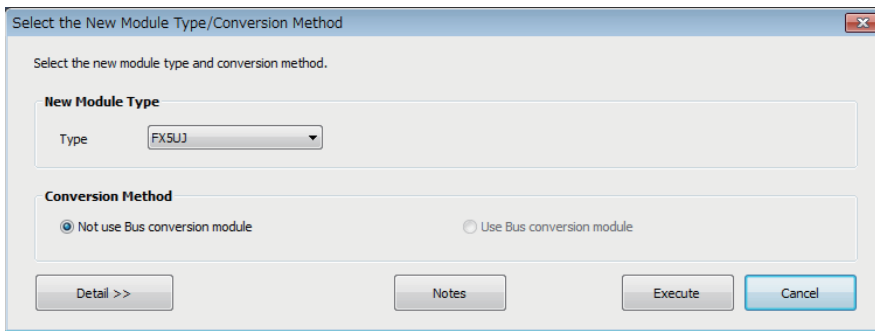

4. When conversion is completed, the following message is shown.

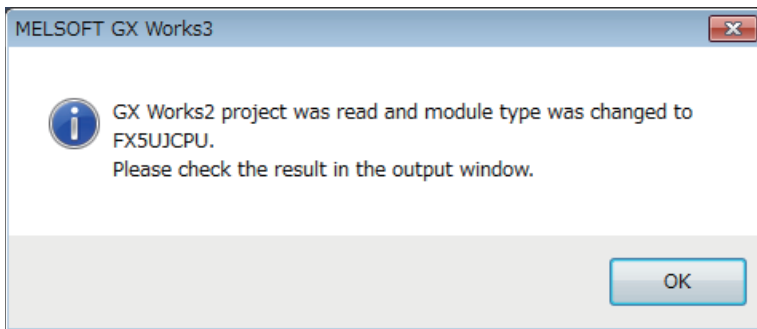

5. Check the contents of the model change result in the "Output window".

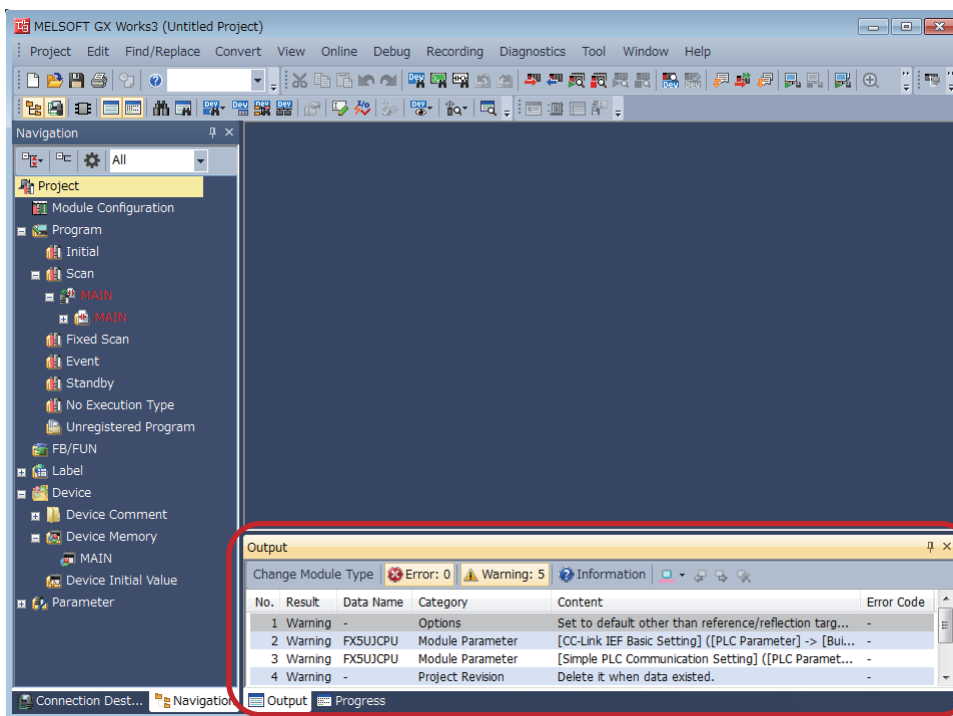

→ Output window

Precautions

- For GX Works3 versions 1.063R or earlier, when changing the model/operation mode from the FX5U to the FX5UJ, device memory entries, device initial values, and device comments that are outside the device range of the FX5UJ will be deleted.
- When projects are converted, the program instructions and devices may be changed. Check the contents of the project. Parameters other than the CC-Link network parameters*1 will be deleted. Set the parameters if necessary.

*1 For details on CC-Link network parameters, refer to Page 43 Precautions when Replacing the Parameters.

6. Set the model name of the CPU for the system parameter.

[System Parameter] ⇒ [I/O Assignment Setting] ⇒ Model Name

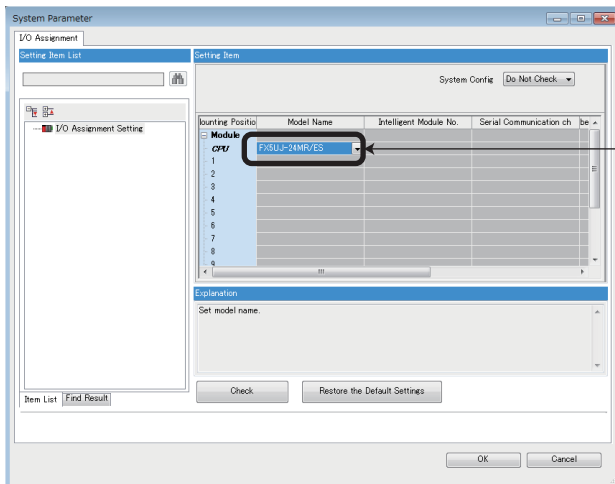

Set the model name of the CPU.

7. Perform conversion.

[Convert] ⇒ [Rebuild All]

Precautions when Converting the Projects

- When converting FX3G projects using GX Works3, be careful because the program (instructions and devices) may be changed.
- When converting projects, the number of steps may increase and writing to the FX5UJ may be impossible. Check the number of steps after replacement.
- Characters used for the label name in GX Works2 may correspond to reserved words or illegal characters in GX Works3. In that case, change the label name.

For precautions regarding instruction and device conversion, refer to Page 92 Instruction Replacement List.

Precautions when Replacing the Parameters

When converting FX3G projects to FX5UJ projects, the setting data of the parameters (PC parameters and network parameters) and special modules (intelligent function modules) will be deleted. Therefore, it is necessary to set the data with GX Works3 again.

Also, GX Works3 does not support the following parameters of the FX3G, so it is necessary to set these parameters with GX Works3 again.

- Network parameters (CC-Link)
- Intelligent function module parameter (AnyWireASLINK)

Precautions when Replacing Other Functions

Precautions when Using the High-speed Counters

When the high-speed counters (C235 to C255) are used with the FX3G, they will not operate just by switching to the FX5UJ. It is necessary to set the FX3 Series compatible high-speed counters and change the program by the parameter. For the setting procedure, refer to the following.

Parameter Setting Procedure of the FX3 Series Compatible High-speed Counters

1. Select "Long Counter Specification" at the specification for High-speed counters.

[Parameter] ⇒ [FX5UJCPU] ⇒ [Module Parameter] ⇒ [High Speed I/O] ⇒ "Input Function" ⇒ "High Speed Counter" ⇒ "Detailed Setting" ⇒ "Other"

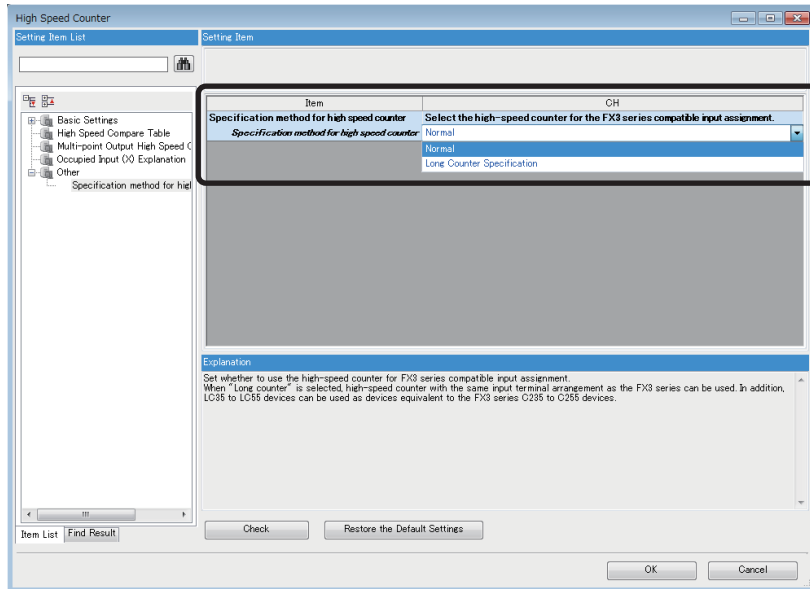

2. Set the function of the high-speed counters used with the FX3G.

Select the input comparison enable/disable of the counter device and preset input compatible with the FX3 Series, and select the control switch.

Item	CH1	CH2	
Use/Do Not Use Counter	Set whether to use counter or not.		
Use/Not Use	Enable	Disable	Disable
Counter device	Select the high-speed counter for the FX3 series compatible input assignment.		
Counter device	LC36 (Operation equivalent to C235)	LC36 (Operation equivalent to C236)	LC37 (Operation equivalent to C237)
Operation Mode	Set operation mode.		
Operation Mode	Normal Mode	Normal Mode	Normal Mode
Pulse Input Mode	Set pulse input mode.		
Pulse Input Mode	1-Phase 1 Input (S/W Up/Down Switch)	1-Phase 1 Input (S/W Up/Down Switch)	1-Phase 1 Input
Preset Input	Set preset input.		
Preset Input Enable/Disable	Disable	Disable	Disable
Input logic	Positive Logic	Positive Logic	Positive Logic
Preset Value	0	0	0
Input Comparison Enable/Disable	Enable	Enable	Enable
Control Switch	Rising	Rising	Rising
Enable Input	Set enable input.		
Enable Input Enable/Disable	Disable	Disable	Disable
Input logic	Positive Logic	Positive Logic	Positive Logic
Ring Length Setting	Set ring length.		
Ring Length Enable/Disable	Disable	Disable	Disable
Ring Length	2147483648	2147483648	2147483648
Measurement Unit Time	Set the measurement unit time (ms) for the pulse density measurement mode and rotation speed measurement mode.		
Measurement Unit Time	1000 ms	1000 ms	1000 ms
Number of Pulses per Rotation	Set the number of pulses per rotation when using the rotation speed measurement mode.		
Number of Pulses per Rotation	1000 pulse	1000 pulse	1000 pulse

■ Changing the Program

Change the high-speed counter program by referring to the following program example.

[Example of program]

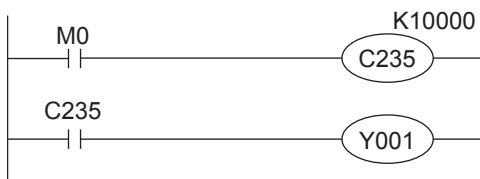

↓ Change the program.

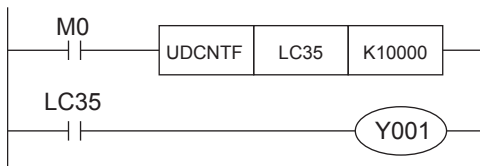

Precautions when Using the Routine Timer

When the routine timer (T192 to T199) is used with the FX3G, it will not operate just by switching to the FX5UJ. The routine timer must be set by the parameter. For the setting procedure, refer to the following.

■ Parameter Setting Procedure of the Routine Timer

Set the use of the routine timer and the leading device number.

[Parameter] ⇒ [FX5UJCPU] ⇒ [CPU Parameter] ⇒ “Memory/Device Setting” ⇒ “Device/Label Memory Area Setting”

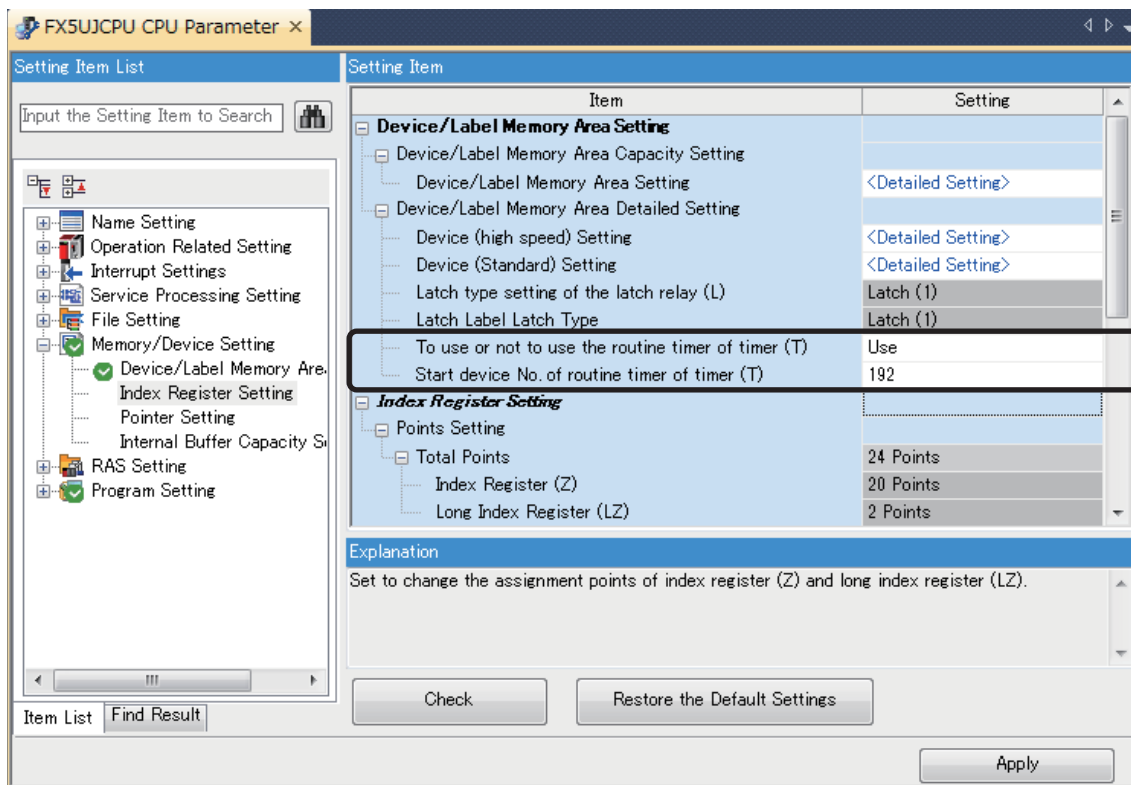

Serial Communication Channel Assignment (RS-485, RS-232C)

When the FX3G is replaced with the FX5UJ, the communication channel assignments that can be used change. Change the communication channels specified with instructions and parameter settings so that these channels match the specifications.

■FX3G communication channel assignment

- FX3G-14M□ and FX3G-24M□

A communication function expansion board and a special communication adapter can be used to connect up to one channel of serial ports.

The configurable combinations are shown below.

[Configuration example 1]

Using a special communication adapter

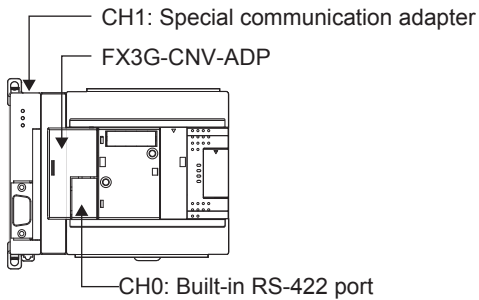

[Configuration example 2]

Using a communication function expansion board

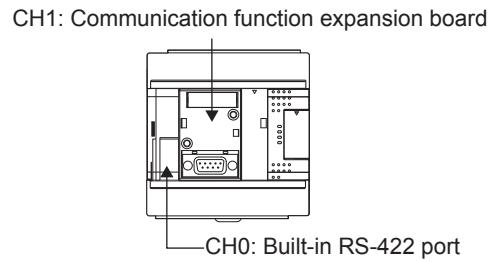

- FX3G-40M□ and FX3G-60M□

A communication function expansion board and a special communication adapter can be used to connect up to two channels of serial ports.

The configurable combinations are shown below.

[Configuration example 1]

Using a communication function expansion board and a special communication adapter at the same time

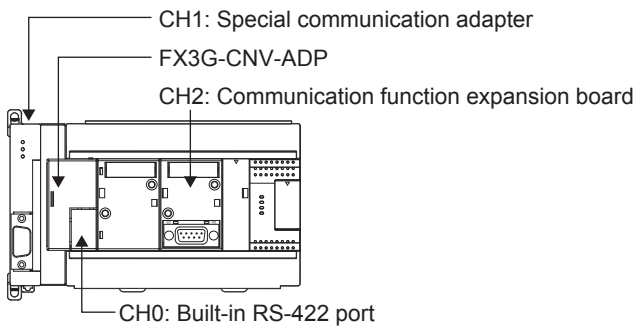

[Configuration example 2]

Using two special communication adapters

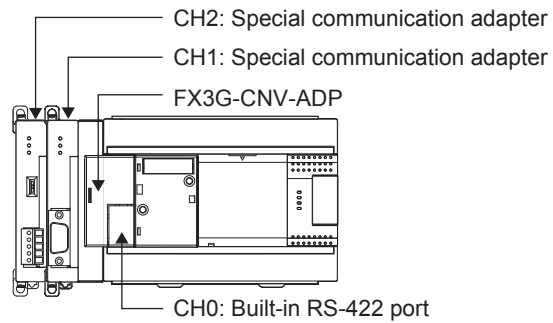

■FX5UJ communication channel assignment

A communication board and a communication adapter can be used to connect up to two channels of serial ports. The communication channel assignments are fixed regardless of the system configuration.

The configurable combinations are shown below.

[Configuration example 1]

[Configuration example 2]

Using a communication board and a communication adapter at the same time

Using two communication adapters

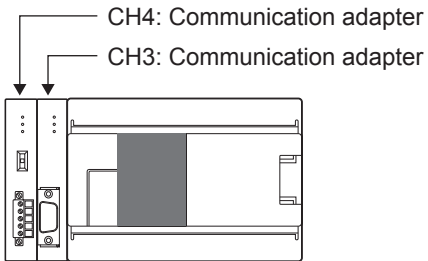
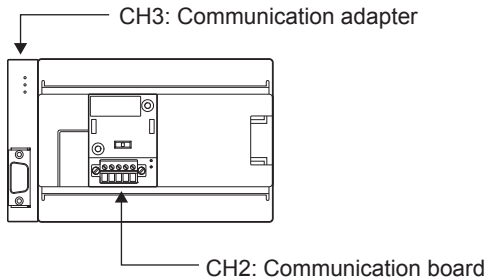

Ex.

When two special communication adapters connected to the FX3G are replaced with two FX5UJ communication adapters, the communication channels change from CH1 and CH2 to CH3 and CH4.

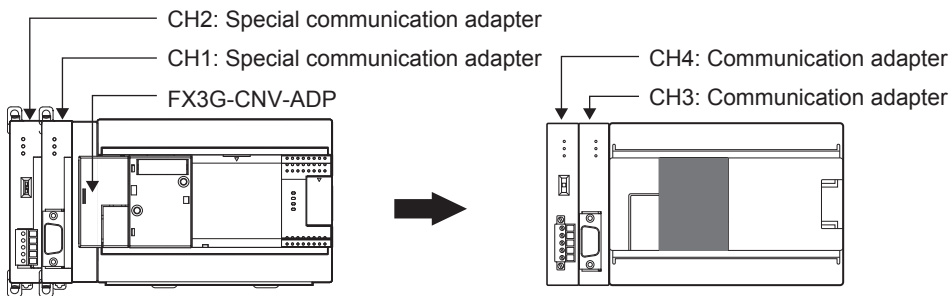

3.5 Replacement of the PLC

The main points to consider during replacement of the CPU module and extension modules are explained below.

For details of each item, check the reference pages in this document, and related manuals such as the PLC Hardware Manual and Programming Manual.

Device classification	Item	Operation content and points of attention	Reference page
CPU module	Reuse of the input/output wiring	Perform rewiring for the connection part of the terminal block type.	☞ Page 35
Other extension modules	Wiring to each module		
Verifying operation of the equipment	Operation and test of the PLC program	Operate the converted PLC program and hardware devices, and check and adjust the device function and operation timing. Be aware of the precautions described on the reference page for replacing the project, and check that the devices operate as they are designed.	☞ Page 41

4 Replacement from FX3U to FX5UJ

4.1 Outline

The FX5UJ is equipped with communication, high-speed input/output, etc. and can easily be expanded with expansion boards and expansion adapters. Up to eight I/O modules and FX5 intelligent function modules (combined) can be connected. The procedures and points for replacing an existing model with the FX5UJ are shown below. Use this information to consider replacing existing models.

Points to Consider

- The “recommended substitute models” are described for individual FX3U and extension modules that can be replaced by iQ-F Series models. According to usage and system configuration (connection status of the extension modules), and cases when the I/O numbers actually used are small, other models than the described “recommended substitute models” may be suitable for replacement.
- The recommended substitute models for items such as extension modules and function expansion boards are described with those that can be connected to the FX5UJ CPU module.
- Contents that require special caution when replacing each model are described in “Special notes”. Most recommended substitute models have various differences in the specifications other than those in “Special notes” such as the dimensions becoming smaller than the current models. Therefore, when considering usage, please check not only the “Special notes” but also the details of various specifications such as the dimensions and power specifications in the manual.
- Based on the above conditions, “No recommended substitute models” is described for those without a recommended substitute model, but there are cases that can be replaced with an FX5UJ system configuration according to usage and system configuration. Check the necessary functions and features when considering the replacement with FX5UJ system configuration.

4.2 Replacement Procedure

The procedure for replacing the FX3U with the FX5UJ is shown below.

For details on replacing the FX3U with the FX5U, refer to  Page 63 Replacement from FX3U to FX5U.

1. Selection of the models

Select the substitute models.

 Page 50 Selection of Substitute Models

2. Conversion of the program

Convert the program used in FX3U to be able to use in FX5UJ.

 Page 56 Conversion of the Projects

3. Replacement to the substitute models

Replace the PLCs.

 Page 62 Replacement of the PLC

4.3 Selection of Substitute Models

Recommended Substitute Models

Recommended Substitute Models for CPU Modules

The recommended substitute models of FX5UJ compatible with FX3U are introduced.

Please consider to replace the currently used CPU modules to the following recommended substitute models.

■List of recommended substitute models (CPU modules) for FX3U → FX5UJ replacement

FX3U Series		Recommended substitute models	Special notes
Device name	Model name	Model name	
CPU module	FX3U-16MR/ES	FX5UJ-24MR/ES	The number of I/O increases in the recommended substitute models.
	FX3U-16MT/ES	FX5UJ-24MT/ES	The number of I/O increases in the recommended substitute models.
	FX3U-16MT/ESS	FX5UJ-24MT/ESS	The number of I/O increases in the recommended substitute models.
	FX3U-32MR/ES	FX5UJ-40MR/ES	The number of I/O increases in the recommended substitute models.
	FX3U-32MS/ES	No recommended substitute models	
	FX3U-32MT/ES	FX5UJ-40MT/ES	The number of I/O increases in the recommended substitute models.
	FX3U-32MT/ESS	FX5UJ-40MT/ESS	The number of I/O increases in the recommended substitute models.
	FX3U-48MR/ES	FX5UJ-40MR/ES+FX5-8EYR/ES	
	FX3U-48MT/ES	FX5UJ-40MT/ES+FX5-8EYT/ES	
	FX3U-48MT/ESS	FX5UJ-40MT/ESS+FX5-8EYT/ESS	
	FX3U-64MR/ES	FX5UJ-60MR/ES+FX5-8EYR/ES	The number of I/O increases in the recommended substitute models.
	FX3U-64MS/ES	No recommended substitute models	
	FX3U-64MT/ES	FX5UJ-60MT/ES+FX5-8EYT/ES	The number of I/O increases in the recommended substitute models.
	FX3U-64MT/ESS	FX5UJ-60MT/ESS+FX5-8EYT/ESS	The number of I/O increases in the recommended substitute models.
	FX3U-80MR/ES	FX5UJ-60MR/ES+FX5-8EX+FX5-16EYR/ES	The number of I/O increases in the recommended substitute models.
	FX3U-80MT/ES	FX5UJ-60MT/ES+FX5-8EX+FX5-16EYT/ES	The number of I/O increases in the recommended substitute models.
	FX3U-80MT/ESS	FX5UJ-60MT/ESS+FX5-8EX+FX5-16EYT/ESS	The number of I/O increases in the recommended substitute models.
	FX3U-128MR/ES	FX5UJ-60MR/ES+FX5-32ER/ES+FX5-32ER/ES+FX5-8EYR/ES	The number of I/O increases in the recommended substitute models.
	FX3U-128MT/ES	FX5UJ-60MT/ES+FX5-32ET/ES+FX5-32ET/ES+FX5-8EYT/ES	The number of I/O increases in the recommended substitute models.
	FX3U-128MT/ESS	FX5UJ-60MT/ESS+FX5-32ET/ESS+FX5-32ET/ESS+FX5-8EYT/ESS	The number of I/O increases in the recommended substitute models.
	FX3U-16MR/DS	No recommended substitute models	
	FX3U-16MT/DS	No recommended substitute models	
	FX3U-16MT/DSS	No recommended substitute models	
	FX3U-32MR/DS	No recommended substitute models	
	FX3U-32MT/DS	No recommended substitute models	
	FX3U-32MT/DSS	No recommended substitute models	
	FX3U-48MR/DS	No recommended substitute models	
	FX3U-48MT/DS	No recommended substitute models	
	FX3U-48MT/DSS	No recommended substitute models	
	FX3U-64MR/DS	No recommended substitute models	
	FX3U-64MT/DS	No recommended substitute models	
	FX3U-64MT/DSS	No recommended substitute models	
FX3U-80MR/DS	No recommended substitute models		
FX3U-80MT/DS	No recommended substitute models		
FX3U-80MT/DSS	No recommended substitute models		
FX3U-32MR/UA1	No recommended substitute models		
FX3U-64MR/UA1	No recommended substitute models		

Recommended Substitute Models for Extension Devices

The following list shows the extension devices that will be necessary to replace simultaneously when replacing the CPU module from FX3U to FX5UJ.

For products without a substitute model of the same function, check the contents described in the Special notes and please consider system reconfiguration.

■List of extension devices required to replace when replacing the CPU module from FX3U to FX5UJ

Extension device		Recommended substitute models	Special notes
Device name	Model name	Model name	
Extension I/O	FX2N-8ER	FX5-16ER/ES	The number of I/O increases in the recommended substitute models.
	FX2N-8ER-ES/UL	FX5-16ER/ES	The number of I/O increases in the recommended substitute models.
	FX2N-8EX	FX5-8EX/ES	
	FX2N-8EX-ES/UL	FX5-8EX/ES	
	FX2N-8EX-UA1/UL	No recommended substitute models	
	FX2N-16EX	FX5-16EX/ES	
	FX2N-16EX-ES/UL	FX5-16EX/ES	
	FX2N-16EX-C	FX5-CNV-IF+FX5-C16EX/D	Only a connector type module can be connected after (on the right side of) FX5-CNV-IF.
	FX2N-16EXL-C	No recommended substitute models	
	FX2N-8EYR	FX5-8EYR/ES	
	FX2N-8EYR-ES/UL	FX5-8EYR/ES	
	FX2N-8EYR-S-ES/UL	No recommended substitute models	
	FX2N-8EYT	FX5-8EYT/ES	
	FX2N-8EYT-ESS/UL	FX5-8EYT/ESS	
	FX2N-8EYT-H	No recommended substitute models	
	FX2N-16EYR	FX5-16EYR/ES	
	FX2N-16EYR-ES/UL	FX5-16EYR/ES	
	FX2N-16EYT	FX5-16EYT/ES	
	FX2N-16EYT-ESS/UL	FX5-16EYT/ESS	
	FX2N-16EYT-C	FX5-CNV-IF+FX5-C16EYT/D	Only a connector type module can be connected after (on the right side of) FX5-CNV-IF.
	FX2N-16EYS	No recommended substitute models	
	FX2N-32ER	FX5-32ER/ES	
	FX2N-32ER-ES/UL	FX5-32ER/ES	
	FX2N-32ET	FX5-32ET/ES	
	FX2N-32ET-ESS/UL	FX5-32ET/ESS	
	FX2N-32ES	No recommended substitute models	
	FX2N-48ER	FX5-32ER/ES+FX5-16ER/ES	
	FX2N-48ER-ES/UL	FX5-32ER/ES+FX5-16ER/ES	
	FX2N-48ET	FX5-32ET/ES+FX5-16ET/ES	
	FX2N-48ET-ESS/UL	FX5-32ET/ESS+FX5-16ET/ESS	
	FX2N-48ER-D	No recommended substitute models	
	FX2N-48ER-DS	No recommended substitute models	
	FX2N-48ET-D	No recommended substitute models	
FX2N-48ET-DSS	No recommended substitute models		
FX2N-48ER-UA1/UL	No recommended substitute models		

Extension device		Recommended substitute models	Special notes
Device name	Model name	Model name	
Extension device	FX3U-1PSU-5V	FX5-1PSU-5V	
	FX2N-4AD-TC	FX5-4AD-TC-ADP	The wiring must be replaced from the screw terminal block to the European terminal block.
	FX2N-4AD-PT	FX5-4AD-PT-ADP	
	FX2N-5A	FX5-4AD+FX5-4DA	The wiring must be replaced from the screw terminal block to the spring clamp terminal block.
	FX2N-2AD	FX5-4AD	The wiring must be replaced from the screw terminal block to the spring clamp terminal block.
	FX2N-8AD	FX5-8AD	The wiring must be replaced from the screw terminal block to the spring clamp terminal block.
	FX3U-4AD	FX5-4AD	The wiring must be replaced from the screw terminal block to the spring clamp terminal block.
	FX2N-2LC	FX5-4LC	The wiring must be replaced from the screw terminal block to the spring clamp terminal block.
	FX3U-4LC	FX5-4LC	The wiring must be replaced from the screw terminal block to the spring clamp terminal block.
	FX2N-2DA	FX5-4DA	The wiring must be replaced from the screw terminal block to the spring clamp terminal block.
	FX3U-4DA	FX5-4DA	The wiring must be replaced from the screw terminal block to the spring clamp terminal block.
	FX2N-1HC	No recommended substitute models	
	FX3U-2HC	No recommended substitute models	
	FX2N-10PG	FX5-20PG-D	Replacement is necessary due to the difference of the connector type.
	FX3U-1PG	FX5-20PG-P	The wiring must be replaced from the screw terminal block to the external device connector.
	FX3U-20SSC-H	FX5-40SSC-S	Replacement is necessary due to the difference of the connector type for external input connection. One device per system.
	FX2N-232IF	No recommended substitute models	
	FX2N-32CCL	FX5-CCL-MS	Set to the intelligent device station in the recommended substitute models. ^{*1}
	FX2N-64CL-M	No recommended substitute models	
	FX3U-16CCL-M	FX5-CCL-MS	Set to the master station in the recommended substitute models.
	FX3U-64CCL	FX5-CCL-MS	Set to the intelligent device station in the recommended substitute models. ^{*1}
	FX3U-128ASL-M	FX5-ASL-M	
	FX3U-ENET	No recommended substitute models	Ethernet port is built into FX5UJ CPU module.
	FX3U-64DP-M	FX5-DP-M	
	FX3U-32DP	No recommended substitute models	
	FX3U-CAN	No recommended substitute models	
	FX3U-J1939	No recommended substitute models	
	FX2N-10GM	FX5-20PG-P	It cannot be used alone. Replacement is necessary due to the difference of the connector type.
	FX2N-20GM	FX5-20PG-P	It cannot be used alone. Replacement is necessary due to the difference of the connector type.
	FX2N-1RM-SET(-E)	No recommended substitute models	
FX2N-32DP-IF(-D)	No recommended substitute models		
FX2N-64DNET	No recommended substitute models		
Expansion board	FX3U-232-BD	FX5-232-BD	
	FX3U-485-BD	FX5-485-BD	
	FX3U-422-BD	FX5-422-BD-GOT	GOT can only be connected to FX5-422-BD-GOT.
	FX3U-CNV-BD	—	Not necessary for FX5UJ CPU module.
	FX3U-8AV-BD	No recommended substitute models	
	FX3U-USB-BD	No recommended substitute models	USB port is built into the FX5UJ CPU module.

Extension device		Recommended substitute models	Special notes
Device name	Model name	Model name	
Expansion adapter	FX3U-232ADP(-MB)	FX5-232ADP	
	FX3U-485ADP(-MB)	FX5-485ADP	
	FX3U-ENET-ADP	No recommended substitute models	Ethernet port is built into FX5UJ CPU module.
	FX3U-3A-ADP	FX5-4A-ADP	
	FX3U-4AD-ADP	FX5-4AD-ADP	
	FX3U-4DA-ADP	FX5-4DA-ADP	
	FX3U-4AD-PT-ADP	FX5-4AD-PT-ADP	
	FX3U-4AD-PTW-ADP	FX5-4AD-PT-ADP	
	FX3U-4AD-PNK-ADP	No recommended substitute models	
	FX3U-4AD-TC-ADP	FX5-4AD-TC-ADP	
	FX3U-4HSX-ADP	No recommended substitute models	
	FX3U-2HSY-ADP	No recommended substitute models	
	FX3U-CF-ADP	No recommended substitute models	Substituted by an SD memory card.
Option	FX3U-FLROM-16	No recommended substitute models	Substituted by an SD memory card.
	FX3U-FLROM-64	No recommended substitute models	Substituted by an SD memory card.
	FX3U-FLROM-64L	No recommended substitute models	Substituted by an SD memory card.
	FX3U-FLROM-1M	No recommended substitute models	Substituted by an SD memory card.
	FX3U-7DM	No recommended substitute models	
	FX-30P	No recommended substitute models	
	FX0N-30EC	FX5-30EC	
	FX0N-65EC	FX5-65EC	
	FX2N-CNV-BC	FX5-CNV-BC	

*1 FX5-CCL-MS can be used as a master station.

Extension devices that can be reused when the CPU module is replaced to FX5UJ

The following extension devices can be used even when the CPU module is replaced (FX3U → FX5UJ).

■ Extension devices that can be used even when the CPU module is replaced from the FX3U to FX5UJ

Terminal module
FX-16E-TB, FX-32E-TB, FX-16EX-A1-TB, FX-16EYR-TB, FX16EYS-TB, FX-16EYT-TB
FX-16E-TB/UL, FX-32E-TB/UL, FX-16EYR-ES-TB/UL, FX-16EYS-ES-TB/UL, FX-16EYT-ES-TB/UL, FX-16EYT-ESS-TB/UL

Battery

The FX5UJ CPU module cannot use a battery. However, the programs and devices of the FX5UJ CPU module are maintained in the built-in flash memory of the CPU.

Note that file registers (R) of the FX5UJ CPU module cannot be latched. (☞ Page 106 Device Replacement List)

Precautions Regarding the Hardware

Comparison of FX3U and FX5UJ and Precautions for Replacement

The following list shows precautions of the hardware. Check details in the manuals of each model when replacing existing models.

■Difference and precautions regarding the main hardware of FX3U and FX5UJ

Item	Difference		Precautions
	FX3U	FX5UJ	
Extension of FX2N and FX3U	Extension possible	Extension not possible	—
Input hardware filter (When the digital filter is 0) • High-speed counter • Input interruption function • Pulse catch function	X0 to X5: 5 μ s X6 and X7: 50 μ s X10 to X17: 200 μ s	■FX5UJ-24M□ X0, X1, X3, and X4: 5 μ s or less when ON and 5 μ s or less when OFF X2, X5, X6, and X7: 30 μ s or less when ON and 50 μ s or less when OFF X10 to X15: 50 μ s or less when ON and 150 μ s or less when OFF ■FX5UJ-40M□ and FX5UJ-60M□ X0, X1, X3, and X4: 5 μ s or less when ON and 5 μ s or less when OFF X2, X5, X6, and X7: 30 μ s or less when ON and 50 μ s or less when OFF X10 to X17: 50 μ s or less when ON and 150 μ s or less when OFF	Noises that were not detected by FX3U may possibly be captured as an input. Take external measures against noise, or set an appropriate input response time parameter.
Input signal current	X0 to X5: 6 mA X6 and X7: 7 mA X10 or later: 5 mA	X0 to X7: 5.3 mA X10 or later: 4 mA	The input signal current has been lowered, so it is necessary to check the specification of the external devices when replacing.

■External dimension drawing

There are some differences in the external dimensions of the FX3U and the FX5UJ. Be careful when replacing the modules.

• FX3U

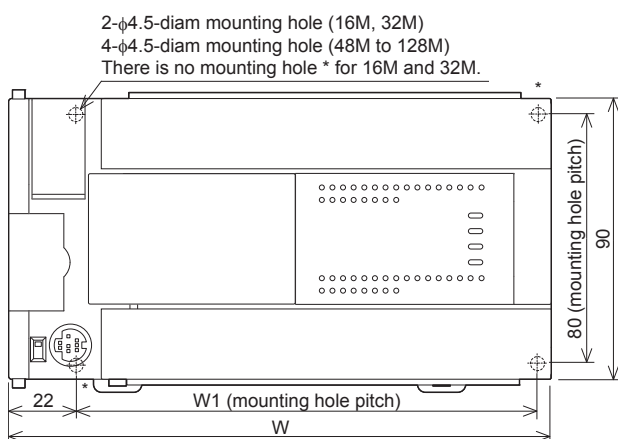

External color: Munsell 0.08GY/7.64/0.81
 Top cover: Munsell N1.5
 Unit: mm
 The terminal block uses M3 terminal screws
 35 mm width DIN rail can be installed

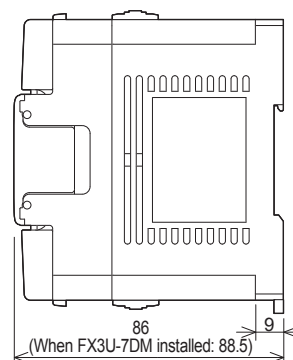

Model name	W: mm	W1: mm	Weight: kg
FX3U-16M□	130	103	Approx. 0.60
FX3U-32M□	150	123	Approx. 0.65
FX3U-48M□, FX3U-32MR/UA1	182	155	Approx. 0.85
FX3U-64M□	220	193	Approx. 1.00
FX3U-80M□, FX3U-64MR/UA1	285	258	Approx. 1.20
FX3U-128M□	350	323	Approx. 1.80

• FX5UJ

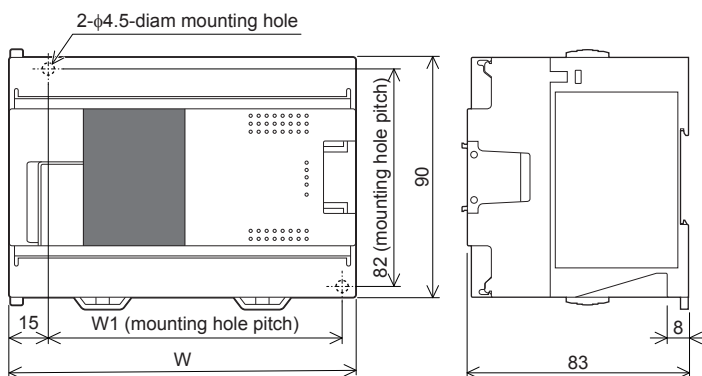

External color: Munsell 0.6B7.6/0.2
 Unit: mm
 The terminal block uses M3 terminal screws
 35 mm width DIN rail can be installed

Model name	W: mm	W1: mm	Weight: kg
FX5UJ-24M□	95	76	Approx. 0.55
FX5UJ-40M□	130	111	Approx. 0.65
FX5UJ-60M□	175	156	Approx. 0.80

■Cable sizes for European type terminal block

Suitable wiring and tightening torque are described below.

	Wire size for one wire	Wire size for two wires	Wire ferrule with insulation sleeve (wire size)	Tightening torque	Stripping dimensions of electric wire ends
FX3U-485-BD, FX3U-485ADP(-MB) FX5-485-BD, FX5-485ADP	AWG22 to AWG20	AWG22	AWG22 to AWG20	0.22 to 0.25 N·m	9 mm
FX5-4AD-ADP, FX5-4DA-ADP, FX5-4A-ADP, FX5-4AD-PT-ADP, FX5-4AD-TC-ADP				0.20 N·m	

■Differences and precautions regarding installing the FX3U and FX5UJ

The pitch of the holes for installation in a control panel and the width differ between the FX3U and FX5UJ. When making a direct installation in a control panel, installation holes must be added. Also, because the terminal block shapes differ, one terminal block cannot be replaced with the other. (☞ Page 54 External dimension drawing)

■Differences and precautions regarding the drive power supply of the output section of the FX3U-16M□ and FX5UJ

- Output section power supply voltage consolidation

When replacing the FX3U-16M□ with the FX5UJ, the power supplies must be consolidated if a separate power supply has been installed with the common terminal of the FX3U-16M□.

- Maximum output load current

When the FX3U-16M□ is replaced with the FX5UJ, the maximum load current of the output section changes.

If separate power supplies have been installed with each common terminal, consolidate the power supplies.

(Example) FX3U-16MT/ES (output side)



<Number of outputs per common>

- 1 common terminal per output

<Maximum output load current>

- Maximum load (resistance load) current of 1 output common terminal: 0.5 A or less

(Example) FX5UJ-24MT/ES (output side)



<Number of outputs per common>

- 1 common terminal per 3 or 4 outputs

<Maximum output load current>

- Maximum load (resistance load) current of 1 output common terminal: 0.5 A or less
- Maximum load (resistance load) current of 3 output common terminal: 0.6 A or less
- Maximum load (resistance load) current of 4 output common terminal: 0.8 A or less

4.4 Conversion of the Projects

When converting FX3U projects to FX5UJ projects, use GX Works3.

After converting the projects, it may be necessary to adjust the programs (instructions, devices) and parameters.

Operation Method for Replacing Projects

To convert FX3U projects to FX5UJ projects, perform operations in GX Works3.

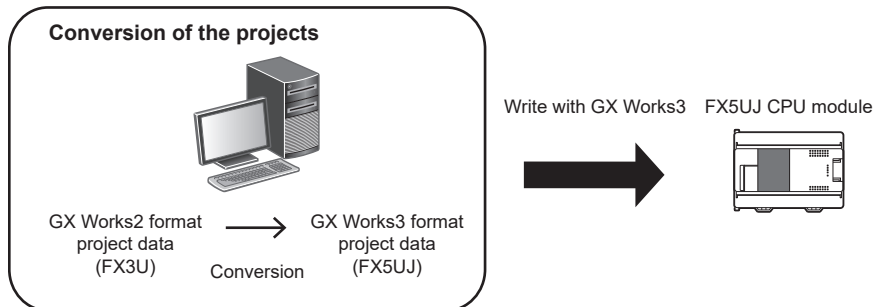

To convert the projects, install the engineering tool of the following version.

Engineering tool	Version	Remarks
GX Works3	1.065T or higher*1	—
GX Works2	1.519R or higher	Supplied with GX Works3.

*1 For GX Works3 version 1.063R and earlier, it is necessary to read FX5U projects beforehand and convert the projects to FX5UJ projects with model/operation mode change.

Precautions

- To read projects of GX Works2 using GX Works3, convert beforehand using GX Works2, and then read the projects. Even for projects converted using GX Works2, conversion may not be performed according to the state of the project. If there is an error in the program, operation will be canceled.
- To read projects of GX Works2 using GX Works3, delete the security (user Management, data security setting) of GX Works2 beforehand and then read the projects. If the security is set to the GX Works2 project, read out will be canceled.
- To read projects of GX Works2 using GX Works3, administrator rights are required.
- FX5UJ does not support the SFC program.

Operating procedure

1. Start up GX Works3.
2. Open the FX3U project.

Select [Project] ⇒ [Open Other Format File] ⇒ [GX Works2 Format] ⇒ [Open Project] ⇒ Project (*.gwx).

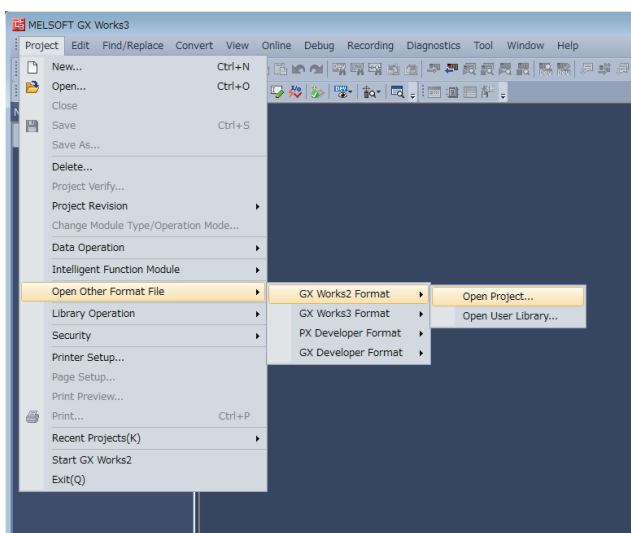

3. The following display is shown.
 A selection screen of the following new module type is shown.
 Select the new module type and press the [Execute] button.

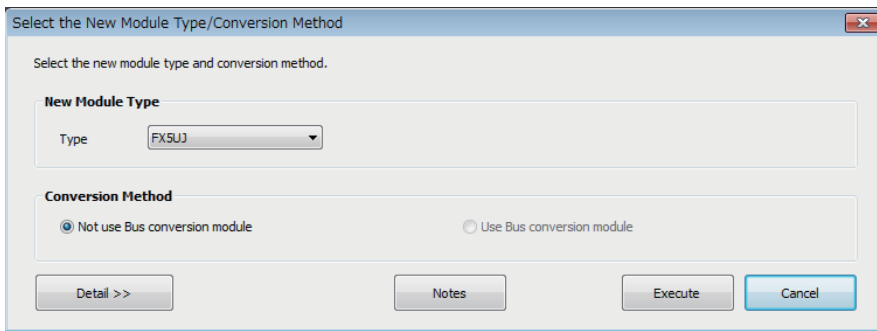

4. When conversion is completed, the following message is shown.

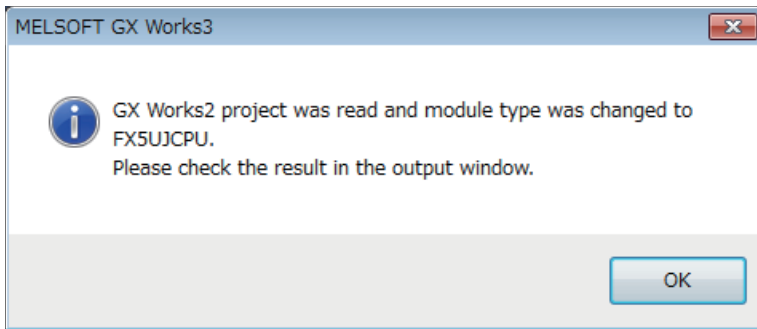

5. Check the contents of the model change result in the "Output window".

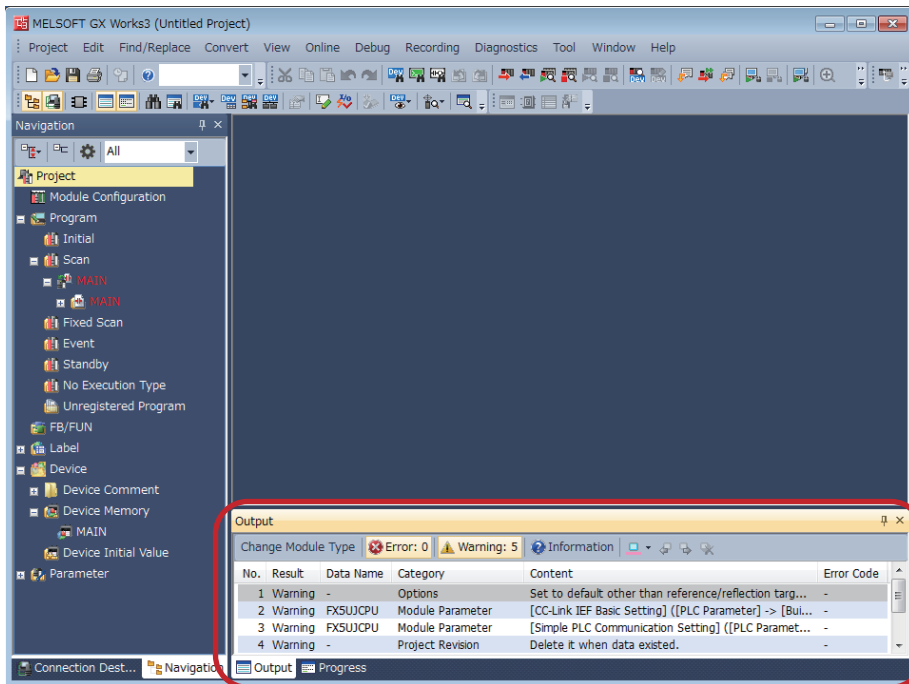

→ Output window

Precautions

- For GX Works3 versions 1.063R or earlier, when changing the model/operation mode from the FX5U to the FX5UJ, device memory entries, device initial values, and device comments that are outside the device range of the FX5UJ will be deleted.
 - When projects are converted, the program instructions and devices may be changed. Check the contents of the project. Parameters other than the CC-Link network parameters*¹ will be deleted. Set the parameters if necessary.
- *¹ For details on CC-Link network parameters, refer to Page 58 Precautions when Replacing the Parameters.

6. Set the model name of the CPU for the system parameter.

[System Parameter] ⇒ [I/O Assignment Setting] ⇒ Model Name

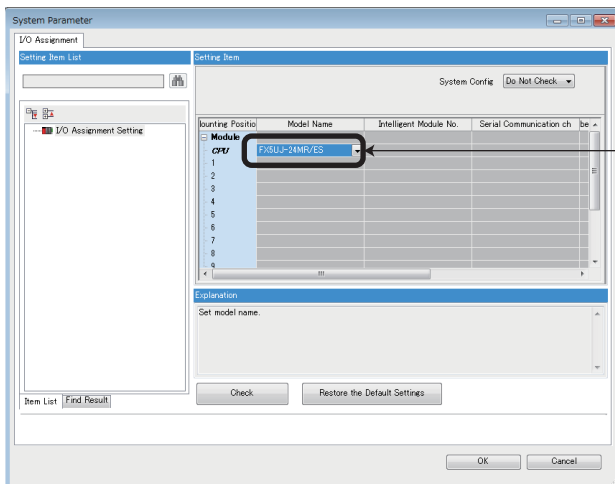

Set the model name of the CPU.

7. Perform conversion.

[Convert] ⇒ [Rebuild All]

Precautions when Converting the Projects

- When converting FX3U projects using GX Works3, be careful because the program (instructions and devices) may be changed.
- When converting projects, the number of steps may increase and writing to the FX5UJ may be impossible. Check the number of steps after replacement.
- Characters used for the label name in GX Works2 may correspond to reserved words or illegal characters in GX Works3. In that case, change the label name.

For precautions regarding instruction and device conversion, refer to Page 92 Instruction Replacement List.

Precautions when Replacing the Parameters

When converting FX3U projects to FX5UJ projects, the setting data of the parameters (PC parameters and network parameters) and special modules (intelligent function modules) will be deleted. Therefore, it is necessary to set the data with GX Works3 again.

Also, GX Works3 does not support the following parameters of the FX3U, so it is necessary to set these parameters with GX Works3 again.

- Network parameters (CC-Link)
- Intelligent function module parameter (AnyWireASLINK)

Precautions when Replacing Other Functions

Precautions when Using the High-speed Counters

When the high-speed counters (C235 to C255) are used with the FX3U, they will not operate just by switching to the FX5UJ. It is necessary to set the FX3 Series compatible high-speed counters and change the program by the parameter. For the setting procedure, refer to the following.

Note that replacing high-speed counters C237, C240, C242, and C245 with FX3 Series compatible high-speed counters LC37, LC40, LC42, and LC45 will decrease the maximum frequency.

If there is a problem with the maximum frequency, consider setting counters to unused LC devices or switching to the FX5U.

Parameter Setting Procedure of the FX3 Series Compatible High-speed Counters

1. Select "Long Counter Specification" at the specification for High-speed counters.

[Parameter] ⇒ [FX5UJCPU] ⇒ [Module Parameter] ⇒ [High Speed I/O] ⇒ "Input Function" ⇒ "High Speed Counter" ⇒ "Detailed Setting" ⇒ "Other"

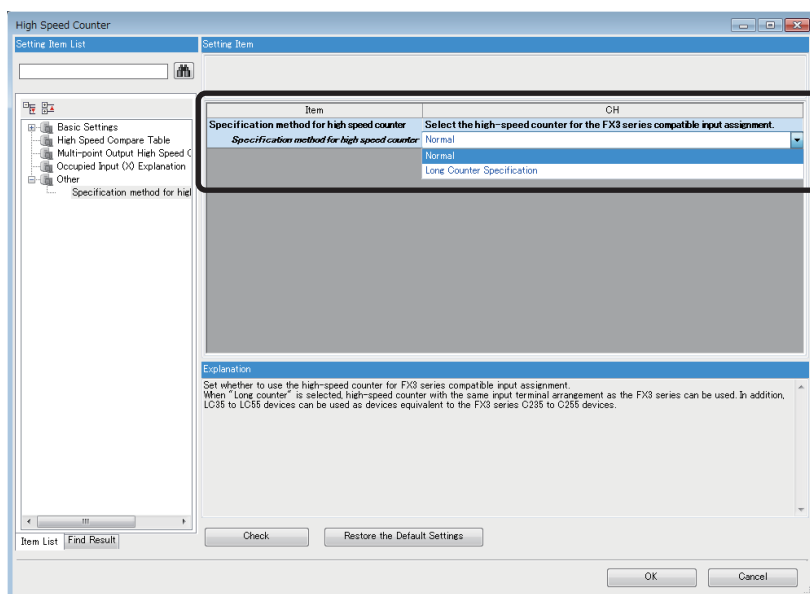

2. Set the function of the high-speed counters used with the FX3U.

Select the input comparison enable/disable of the counter device and preset input compatible with the FX3 Series, and select the control switch.

Item	CH1	CH2	
Use/Do Not Use Counter	Set whether to use counter or not.		
Use/Do Not Use	Enable	Disable	Disable
Counter device	Select the high-speed counter for the FX3 series compatible input assignment.		
Counter device	LC35 (Operation equivalent to C235)	LC36 (Operation equivalent to C236)	LC37 (Operation equivalent to C237)
Operation Mode	Set operation mode.		
Operation Mode	Normal Mode	Normal Mode	Normal Mode
Pulse Input Mode	Set pulse input mode.		
Pulse Input Mode	1-Phase 1 Input (S/W Up/Down Switch)	1-Phase 1 Input (S/W Up/Down Switch)	1-Phase 1 Input
Preset Input	Set preset input.		
Preset Input Enable/Disable	Disable	Disable	Disable
Input logic	Positive Logic	Positive Logic	Positive Logic
Preset Value	0	0	0
Input Comparison Enable/Disable	Enable	Enable	Enable
Control Switch	Rising	Rising	Rising
Enable Input	Set enable input.		
Enable Input Enable/Disable	Disable	Disable	Disable
Input logic	Positive Logic	Positive Logic	Positive Logic
Ring Length Setting	Set ring length.		
Ring Length Enable/Disable	Disable	Disable	Disable
Ring Length	2147483648	2147483648	2147483648
Measurement Unit Time	Set the measurement unit time (ms) for the pulse density measurement mode and rotation speed measurement mode.		
Measurement Unit Time	1000 ms	1000 ms	1000 ms
Number of Pulses per Rotation	Set the number of pulses per rotation when using the rotation speed measurement mode.		
Number of Pulses per Rotation	1000 pulse	1000 pulse	1000 pulse

■ Changing the Program

Change the high-speed counter program by referring to the following program example.

[Example of program]

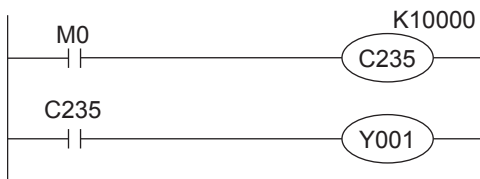

↓ Change the program.

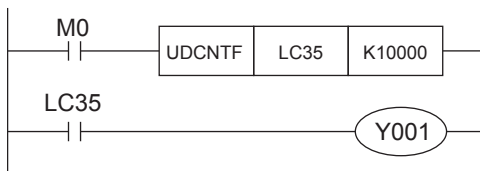

Precautions when Using the Routine Timer

When the routine timer (T192 to T199) is used with the FX3U, it will not operate just by switching to the FX5UJ. The routine timer must be set by the parameter. For the setting procedure, refer to the following.

■ Parameter Setting Procedure of the Routine Timer

Set the use of the routine timer and the leading device number.

[Parameter] ⇒ [FX5UJCPU] ⇒ [CPU Parameter] ⇒ “Memory/Device Setting” ⇒ “Device/Label Memory Area Setting”

Item	Setting
Device/Label Memory Area Setting	
Device/Label Memory Area Capacity Setting	<Detailed Setting>
Device/Label Memory Area Setting	<Detailed Setting>
Device/Label Memory Area Detailed Setting	<Detailed Setting>
Device (high speed) Setting	<Detailed Setting>
Device (Standard) Setting	<Detailed Setting>
Latch type setting of the latch relay (L)	Latch (1)
Latch Label Latch Type	Latch (1)
To use or not to use the routine timer of timer (T)	Use
Start device No. of routine timer of timer (T)	192
Index Register Setting	
Points Setting	
Total Points	24 Points
Index Register (Z)	20 Points
Long Index Register (LZ)	2 Points

Explanation
Set to change the assignment points of index register (Z) and long index register (LZ).

Serial Communication Channel Assignment (RS-485, RS-232C)

When the FX3U is replaced with the FX5UJ, the communication channel assignments that can be used change. Change the communication channels specified with instructions and parameter settings so that these channels match the specifications.

■FX3U communication channel assignment

A communication function expansion board and a special communication adapter can be used to connect up to two channels of serial ports.

The configurable combinations are shown below.

[Configuration example 1]

Using a communication function expansion board and a special communication adapter at the same time

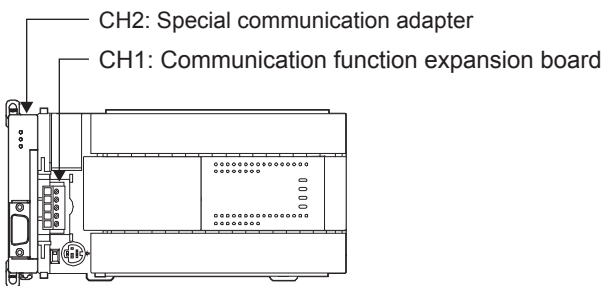

[Configuration example 2]

Using two special communication adapters

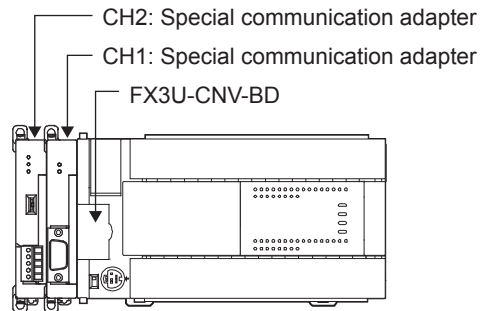

■FX5UJ communication channel assignment

A communication board and a communication adapter can be used to connect up to two channels of serial ports.

The communication channel assignments are fixed regardless of the system configuration.

The configurable combinations are shown below.

[Configuration example 1]

Using a communication board and a communication adapter at the same time

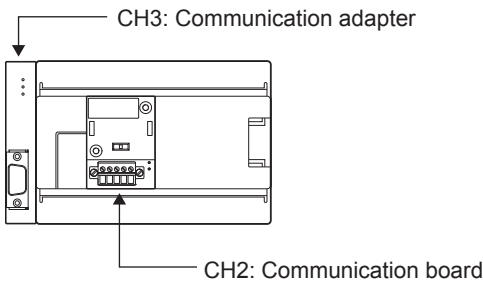

[Configuration example 2]

Using two communication adapters

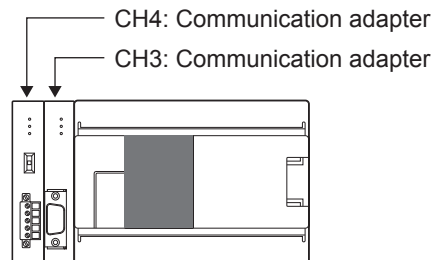

Ex.

When a communication function expansion board connected to the FX3U is replaced with an FX5UJ communication board, the communication channel changes from CH1 to CH2.

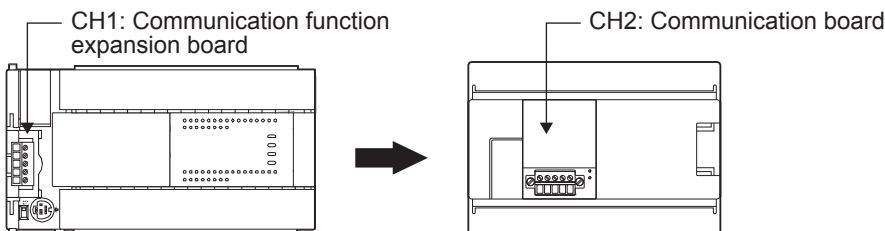

4.5 Replacement of the PLC

The main points to consider during replacement of the CPU module and extension modules are explained below.

For details of each item, check the reference pages in this document, and related manuals such as the PLC Hardware Manual and Programming Manual.

Device classification	Item	Operation content and points of attention	Reference page
CPU module	Reuse of the input/output wiring	Perform rewiring for the connection part of the terminal block type.	☞ Page 50
Other extension modules	Wiring to each module		
Verifying operation of the equipment	Operation and test of the PLC program	Operate the converted PLC program and hardware devices, and check and adjust the device function and operation timing. Be aware of the precautions described on the reference page for replacing the project, and check that the devices operate as they are designed.	☞ Page 56

5 Replacement from FX3U to FX5U

5.1 Outline

The FX5U is equipped with analog functions, communication, high-speed input/output, etc. and can easily be expanded with expansion boards and expansion adapters. The high-speed system bus communication brings out the maximum performance of extension modules equipped with intelligent functions.

The procedures and points for replacing an existing model with the FX5U are shown below. Use this information to consider replacing existing models.

Points to Consider

- The “recommended substitute models” are described for individual FX3U and extension modules that can be replaced by iQ-F Series models. According to usage and system configuration (connection status of the extension modules), and cases when the I/O numbers actually used are small, other models than the described “recommended substitute models” may be suitable for replacement.
- The recommended substitute models for extension modules, function expansion boards and built-in batteries are described with those that can be connected to the FX5U CPU module.
- Contents that require special caution when replacing each model are described in “Special notes”. Most recommended substitute models have various differences in specifications other than those in “Special notes” such as the dimension becoming smaller than the current models. Therefore, when considering usage, please check not only the “Special notes” but also the details of each specification for the dimension and power specifications etc., in the manual.
- Based on the above conditions, “No recommended substitute models” is described for those without a recommended substitute model, but there are cases that can be replaced with an FX5U system configuration according to usage and system configuration. Check the necessary functions and features when considering the replacement with FX5U system configuration.

5.2 Replacement Procedure

The procedure for replacing the FX3U with the FX5U is shown below.

For details on replacing the FX3U with the FX5UJ, refer to  Page 49 Replacement from FX3U to FX5UJ.

1. Selection of the models

Select the substitute models.

 Page 64 Selection of Substitute Models

2. Conversion of the program

Convert the program used in FX3U to be able to use in FX5U.

 Page 70 Conversion of the Projects

3. Replacement to the substitute models

Replace the PLCs.

 Page 76 Replacement of the PLC

5.3 Selection of Substitute Models

Recommended Substitute Models

Recommended Substitute Models for CPU Modules

The recommended substitute models of FX5U compatible with FX3U are introduced.

Please consider to replace the currently used CPU modules to the following recommended substitute models.

■List of recommended substitute models (CPU modules) for FX3U → FX5U replacement

FX3U Series		Recommended substitute models	Special notes
Device name	Model name	Model name	
CPU module	FX3U-16MR/ES	FX5U-32MR/ES	The number of I/O increases in the recommended substitute models.
	FX3U-16MT/ES	FX5U-32MT/ES	The number of I/O increases in the recommended substitute models.
	FX3U-16MT/ESS	FX5U-32MT/ESS	The number of I/O increases in the recommended substitute models.
	FX3U-32MR/ES	FX5U-32MR/ES	
	FX3U-32MS/ES	No recommended substitute models	
	FX3U-32MT/ES	FX5U-32MT/ES	
	FX3U-32MT/ESS	FX5U-32MT/ESS	
	FX3U-48MR/ES	FX5U-64MR/ES	The number of I/O increases in the recommended substitute models.
	FX3U-48MT/ES	FX5U-64MT/ES	The number of I/O increases in the recommended substitute models.
	FX3U-48MT/ESS	FX5U-64MT/ESS	The number of I/O increases in the recommended substitute models.
	FX3U-64MR/ES	FX5U-64MR/ES	
	FX3U-64MS/ES	No recommended substitute models	
	FX3U-64MT/ES	FX5U-64MT/ES	
	FX3U-64MT/ESS	FX5U-64MT/ESS	
	FX3U-80MR/ES	FX5U-80MR/ES	
	FX3U-80MT/ES	FX5U-80MT/ES	
	FX3U-80MT/ESS	FX5U-80MT/ESS	
	FX3U-128MR/ES	FX5U-80MR/ES+FX5-16ER/ES	
	FX3U-128MT/ES	FX5U-80MT/ES+FX5-16ET/ES	
	FX3U-128MT/ESS	FX5U-80MT/ESS+FX5-16ET/ESS	
	FX3U-16MR/DS	FX5U-32MR/DS	The number of I/O increases in the recommended substitute models.
	FX3U-16MT/DS	FX5U-32MT/DS	The number of I/O increases in the recommended substitute models.
	FX3U-16MT/DSS	FX5U-32MT/DSS	The number of I/O increases in the recommended substitute models.
	FX3U-32MR/DS	FX5U-32MR/DS	
	FX3U-32MT/DS	FX5U-32MT/DS	
	FX3U-32MT/DSS	FX5U-32MT/DSS	
	FX3U-48MR/DS	FX5U-64MR/DS	The number of I/O increases in the recommended substitute models.
	FX3U-48MT/DS	FX5U-64MT/DS	The number of I/O increases in the recommended substitute models.
	FX3U-48MT/DSS	FX5U-64MT/DSS	The number of I/O increases in the recommended substitute models.
	FX3U-64MR/DS	FX5U-64MR/DS	

FX3U Series		Recommended substitute models	Special notes
Device name	Model name	Model name	
CPU module	FX3U-64MT/DS	FX5U-64MT/DS	
	FX3U-64MT/DSS	FX5U-64MT/DSS	
	FX3U-80MR/DS	FX5U-80MR/DS	
	FX3U-80MT/DS	FX5U-80MT/DS	
	FX3U-80MT/DSS	FX5U-80MT/DSS	
	FX3U-32MR/UA1	No recommended substitute models	
	FX3U-64MR/UA1	No recommended substitute models	

Recommended Substitute Models for Extension Devices

The following list shows the extension devices that will be necessary to replace simultaneously when replacing the CPU module from FX3U to FX5U.

For products without a substitute model of the same function, check the contents described in the Special notes and please consider system reconfiguration.

■List of extension devices required to replace when replacing the CPU module from FX3U to FX5U

Extension device		Recommended substitute models	Special notes
Device name	Model name	Model name	
Extension I/O	FX2N-8ER	FX5-16ER/ES	The number of I/O increases in the recommended substitute models.
	FX2N-8ER-ES/UL	FX5-16ER/ES	The number of I/O increases in the recommended substitute models.
	FX2N-8EX	FX5-8EX/ES	
	FX2N-8EX-ES/UL	FX5-8EX/ES	
	FX2N-8EX-UA1/UL	No recommended substitute models	
	FX2N-16EX	FX5-16EX/ES	
	FX2N-16EX-ES/UL	FX5-16EX/ES	
	FX2N-16EX-C	FX5-CNV-IF+FX5-C16EX/D	Only a connector type module can be connected after (on the right side of) FX5-CNV-IF.
	FX2N-16EXL-C	No recommended substitute models	
	FX2N-8EYR	FX5-8EYR/ES	
	FX2N-8EYR-ES/UL	FX5-8EYR/ES	
	FX2N-8EYR-S-ES/UL	No recommended substitute models	
	FX2N-8EYT	FX5-8EYT/ES	
	FX2N-8EYT-ESS/UL	FX5-8EYT/ESS	
	FX2N-8EYT-H	No recommended substitute models	
	FX2N-16EYR	FX5-16EYR/ES	
	FX2N-16EYR-ES/UL	FX5-16EYR/ES	
	FX2N-16EYT	FX5-16EYT/ES	
	FX2N-16EYT-ESS/UL	FX5-16EYT/ESS	
	FX2N-16EYT-C	FX5-CNV-IF+FX5-C16EYT/D	Only a connector type module can be connected after (on the right side of) FX5-CNV-IF.
	FX2N-16EYS	No recommended substitute models	
	FX2N-32ER	FX5-32ER/ES	
	FX2N-32ER-ES/UL	FX5-32ER/ES	
	FX2N-32ET	FX5-32ET/ES	
	FX2N-32ET-ESS/UL	FX5-32ET/ESS	
	FX2N-32ES	No recommended substitute models	
	FX2N-48ER	FX5-32ER/ES+FX5-16ER/ES	
	FX2N-48ER-ES/UL	FX5-32ER/ES+FX5-16ER/ES	
	FX2N-48ET	FX5-32ET/ES+FX5-16ET/ES	
	FX2N-48ET-ESS/UL	FX5-32ET/ESS+FX5-16ET/ESS	

Extension device		Recommended substitute models	Special notes
Device name	Model name	Model name	
Extension I/O	FX2N-48ER-D	FX5-32ER/DS+FX5-16ER/ES	
	FX2N-48ER-DS	FX5-32ER/DS+FX5-16ER/ES	
	FX2N-48ET-D	FX5-32ET/DS+FX5-16ET/ES	
	FX2N-48ET-DSS	FX5-32ET/DSS+FX5-16ET/ESS	
	FX2N-48ER-UA1/UL	No recommended substitute models	
Extension device	FX3U-1PSU-5V	FX5-1PSU-5V	
	FX2N-4AD-TC	FX5-4AD-TC-ADP	The wiring must be replaced from the screw terminal block to the European terminal block.
	FX2N-4AD-PT	FX5-4AD-PT-ADP	
	FX2N-5A	FX5-4AD+FX5-4DA	The wiring must be replaced from the screw terminal block to the spring clamp terminal block.
	FX2N-2AD	FX5-4AD	The wiring must be replaced from the screw terminal block to the spring clamp terminal block.
	FX2N-8AD	FX5-8AD	The wiring must be replaced from the screw terminal block to the spring clamp terminal block.
	FX2N-2LC	FX5-4LC	The wiring must be replaced from the screw terminal block to the spring clamp terminal block.
	FX2N-2DA	FX5-4DA	The wiring must be replaced from the screw terminal block to the spring clamp terminal block.
	FX2N-1HC	FX3U-2HC ^{*1}	Replacement of the wiring from the screw terminal block to the connector is necessary.
	FX2N-10PG	FX5-20PG-D	Replacement is necessary due to the difference of the connector type.
	FX3U-20SSC-H	FX5-40SSC-S	Replacement is necessary due to the difference of the connector type for external input connection.
	FX2N-232IF	No recommended substitute models	
	FX2N-32CCL	FX5-CCL-MS	Set to the intelligent device station in the recommended substitute models. ^{*2}
	FX2N-64CL-M	No recommended substitute models	
	FX3U-ENET	No recommended substitute models	Ethernet port is built into FX5U CPU module.
	FX3U-64DP-M	FX5-DP-M	
	FX3U-CAN	No recommended substitute models	
	FX3U-J1939	No recommended substitute models	
	FX2N-10GM	FX5-20PG-P	It cannot be used alone. Replacement is necessary due to the difference of the connector type.
	FX2N-20GM	FX5-20PG-P	It cannot be used alone. Replacement is necessary due to the difference of the connector type.
FX2N-1RM-SET(-E)	No recommended substitute models		
FX2N-32DP-IF(-D)	No recommended substitute models		
FX2N-64DNET	No recommended substitute models		
Expansion board	FX3U-232-BD	FX5-232-BD	
	FX3U-485-BD	FX5-485-BD	
	FX3U-422-BD	FX5-422-BD-GOT	GOT can only be connected to FX5-422-BD-GOT.
	FX3U-CNV-BD	—	Not necessary for FX5U CPU module.
	FX3U-8AV-BD	No recommended substitute models	
	FX3U-USB-BD	No recommended substitute models	

Extension device		Recommended substitute models	Special notes
Device name	Model name	Model name	
Expansion adapter	FX3U-232ADP(-MB)	FX5-232ADP	
	FX3U-485ADP(-MB)	FX5-485ADP	
	FX3U-ENET-ADP	No recommended substitute models	Ethernet port is built into FX5U CPU module.
	FX3U-3A-ADP	FX5-4A-ADP	
	FX3U-4AD-ADP	FX5-4AD-ADP	
	FX3U-4DA-ADP	FX5-4DA-ADP	
	FX3U-4AD-PT-ADP	FX5-4AD-PT-ADP	
	FX3U-4AD-PTW-ADP	FX5-4AD-PT-ADP	
	FX3U-4AD-PNK-ADP	No recommended substitute models	
	FX3U-4AD-TC-ADP	FX5-4AD-TC-ADP	
	FX3U-4HSX-ADP	No recommended substitute models	
	FX3U-2HSY-ADP	No recommended substitute models	
	FX3U-CF-ADP	No recommended substitute models	Substituted by an SD memory card.
Option	FX3U-FLROM-16	No recommended substitute models	Substituted by an SD memory card.
	FX3U-FLROM-64	No recommended substitute models	Substituted by an SD memory card.
	FX3U-FLROM-64L	No recommended substitute models	Substituted by an SD memory card.
	FX3U-FLROM-1M	No recommended substitute models	Substituted by an SD memory card.
	FX3U-7DM	No recommended substitute models	
	FX-30P	No recommended substitute models	
	FX0N-30EC	FX5-30EC	
	FX0N-65EC	FX5-65EC	
	FX2N-CNV-BC	FX5-CNV-BC	

*1 It is possible to connect to the system of FX5U CPU module by connecting the bus conversion module (FX5-CNV-BUS).

*2 FX5-CCL-MS can be used as a master station.

Extension devices that can be reused when the CPU module is replaced to FX5U

The following extension devices can be used by connecting a bus conversion module (FX5-CNV-BUS) even when the CPU module is replaced (FX3U → FX5U).

■ Extension devices that can be used even when the CPU module is replaced from the FX3U to FX5U

Extension power supply	Analog	Positioning	High-speed counter	Network	Terminal module ^{*1}	
FX3U-1PSU-5V	FX3U-4AD FX3U-4DA FX3U-4LC	FX3U-1PG	FX3U-2HC	FX3U-16CCL-M ^{*2} FX3U-64CCL FX3U-128ASL-M ^{*2} FX3U-32DP	FX-16E-TB FX-32E-TB FX-16EX-A1-TB FX-16EYR-TB FX-16EYS-TB FX-16EYT-TB	FX-16E-TB/UL FX-32E-TB/UL FX-16EYR-ES-TB/UL FX-16EYS-ES-TB/UL FX-16EYT-ES-TB/UL FX-16EYT-ESS-TB/UL

*1 The terminal module can be used without connecting a bus conversion module.

*2 It is necessary to set the parameter with the PLC program.

Battery

The battery (FX3U-32BL) used in FX3U can also be used with FX5U.

Precautions Regarding the Hardware

Comparison of FX3U and FX5U and Precautions for Replacement

The following list shows precautions of the hardware. Check details in the manuals of each model when replacing.

■Difference and precautions regarding the main hardware of FX3U and FX5U

Item	Difference		Precautions
	FX3U	FX5U	
Extension of FX2N and FX3U	Extension possible	Extension is possible only for certain modules. FX5-CNV-BUS is required for extension.	Connection is not possible for some intelligent modules of FX3U.
Input hardware filter (When the digital filter is 0) • High-speed counter • Input interruption function • Pulse catch function	X0 to X5: 5 μ s X6 and X7: 50 μ s X10 to X17: 200 μ s	<p>■In the case of FX5U-32M</p> X0 to X5: • ON: 2.5 μ s or less • OFF: 2.5 μ s or less X6 to X17: • ON: 30 μ s or less • OFF: 50 μ s or less <p>■In the case of FX5U-64M and FX5U-80M</p> X0 to X7: • ON: 2.5 μ s or less • OFF: 2.5 μ s or less X10 to X17: • ON: 30 μ s or less • OFF: 50 μ s or less X20 or later: • ON: 50 μ s or less • OFF: 150 μ s or less	Noises that were not detected by FX3U may possibly be captured as an input. Take external measures against noise, or set an appropriate input response time parameter.
Input signal current	X0 to X5: 6 mA X6 and X7: 7 mA X10 or later: 5 mA	X0 to X17: 5.3 mA X20 or later: 4 mA	The input signal current has been lowered, so it is necessary to check the specification of the external devices when replacing.

■External dimension drawing

There are some differences in the external dimensions of the FX3U and the FX5U. Be careful when replacing the modules.

• FX3U

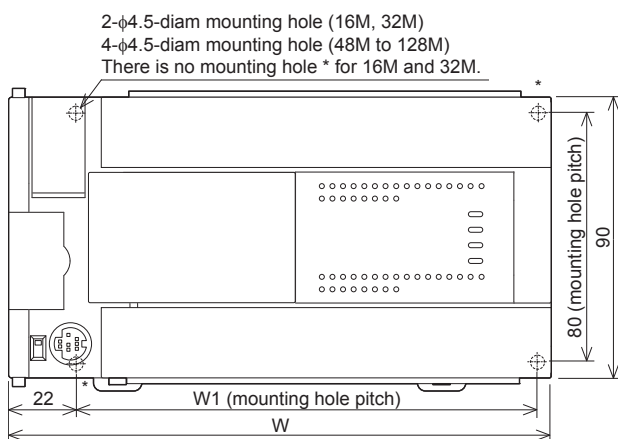

External color: Munsell 0.08GY/7.64/0.81

Top cover: Munsell N1.5

Unit: mm

The terminal block uses M3 terminal screws

35 mm width DIN rail can be installed

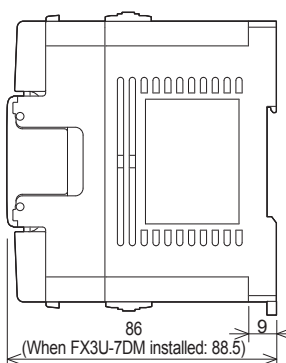

Model name	W: mm	W1: mm	Weight: kg
FX3U-16M□	130	103	Approx. 0.60
FX3U-32M□	150	123	Approx. 0.65
FX3U-48M□, FX3U-32MR/UA1	182	155	Approx. 0.85
FX3U-64M□	220	193	Approx. 1.00
FX3U-80M□, FX3U-64MR/UA1	285	258	Approx. 1.20
FX3U-128M□	350	323	Approx. 1.80

• FX5U

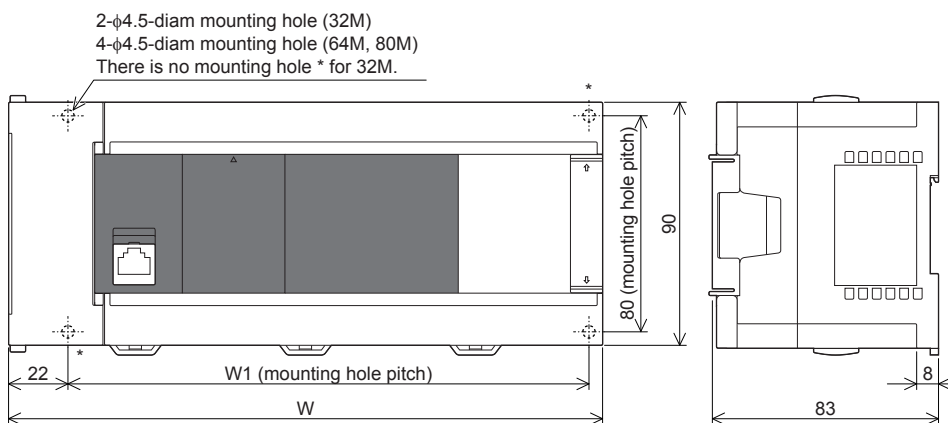

External color: Munsell 0.6B7.6/0.2
 Unit: mm
 The terminal block uses M3 terminal screws
 35 mm width DIN rail can be installed

Model name	W: mm	W1: mm	Weight: kg
FX5U-32M□	150	123	Approx. 0.70
FX5U-64M□	220	193	Approx. 1.00
FX5U-80M□	285	258	Approx. 1.20

■ Cable sizes for European type terminal block

Suitable wiring and tightening torque are described below.

	Wire size for one wire	Wire size for two wires	Wire ferrule with insulation sleeve (wire size)	Tightening torque	Stripping dimensions of electric wire ends
Built-in RS-485 communication terminal block Built-in analog I/O terminal block	AWG24 to AWG20	AWG24	AWG24 to AWG20	0.22 to 0.25 N·m	5 mm
FX3U-485-BD, FX3U-485ADP(-MB) FX5-485-BD, FX5-485ADP	AWG22 to AWG20	AWG22	AWG22 to AWG20	0.22 to 0.25 N·m	9 mm
FX5-4AD-ADP, FX5-4DA-ADP, FX5-4A-ADP, FX5-4AD-PT-ADP, FX5-4AD-TC-ADP				0.20 N·m	

■ Differences and precautions regarding installing the FX3U and FX5U

The FX3U and FX5U CPU modules have the same vertical and horizontal sizes, but the pitch of the installation holes in a horizontal control panel will differ depending on the model name of the FX5U switched to. When making a direct installation in a control panel, installation holes must be added. Also, because the terminal block shapes differ, one terminal block cannot be replaced with the other. (👉 Page 68 External dimension drawing)

■ Differences and precautions regarding the drive power supply of the output section of the FX3U-16M□ and FX5U

- Output section power supply consolidation

When replacing the FX3U-16M□ with the FX5U, the power supplies must be consolidated if a separate power supply has been installed with the common terminal of the FX3U-16M□.

- Maximum output load current

When the FX3U-16M□ is replaced with the FX5U, the maximum load current of the output section changes.

If separate power supplies have been installed with each common terminal, consolidate the power supplies.

(Example) FX3U-16MT/ES (output side)



- <Number of outputs per common>
- 1 common terminal per output
- <Maximum output load current>
- Maximum load (resistance load) current of 1 output common terminal: 0.5 A or less

(Example) FX5U-32MT/ES (output side)



- <Number of outputs per common>
- 1 common terminal per 3 or 4 outputs
- <Maximum output load current>
- Maximum load (resistance load) current of 4 output common terminal: 0.8 A or less
 - Maximum load (resistance load) current of 8 output common terminal: 1.6 A or less

5.4 Conversion of the Projects

When converting FX3U projects to FX5U projects, use GX Works3.

After converting the projects, it may be necessary to adjust the programs (instructions, devices) and parameters.

For the replacement of the SFC program, refer to  Page 116 Conversion of the SFC Program.

Operation Method for Replacing Projects

To convert FX3U projects to FX5U projects, perform operations in GX Works3.

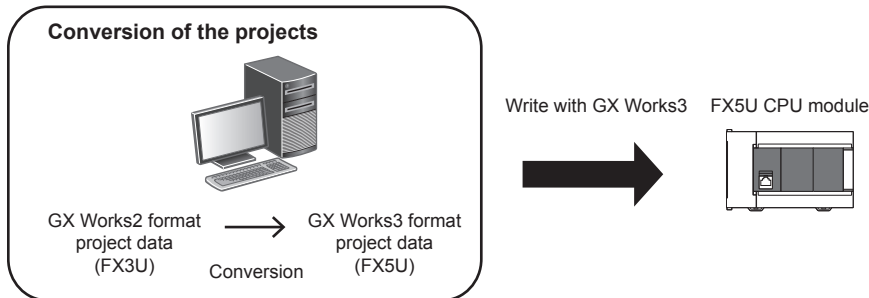

To convert the projects, install the engineering tool of the following version.

Engineering tool	Version	Remarks
GX Works3	1.020W or higher	—
GX Works2	1.519R or higher	Supplied with GX Works3.

Precautions

- To read projects of GX Works2 using GX Works3, convert beforehand using GX Works2, and then read the projects. Even for projects converted using GX Works2, conversion may not be performed according to the state of the project. If there is an error in the program, operation will be canceled.
- To read projects of GX Works2 using GX Works3, delete the security (user Management, data security setting) of GX Works2 beforehand and then read the projects. If the security is set to the GX Works2 project, read out will be canceled.
- To read projects of GX Works2 using GX Works3, administrator rights are required.

Operating procedure

1. Start up GX Works3.
2. Open the FX3U project.

 Select [Project] ⇒ [Open Other Format File] ⇒ [GX Works2 Format] ⇒ [Open Project] ⇒ Project (***.gwx).

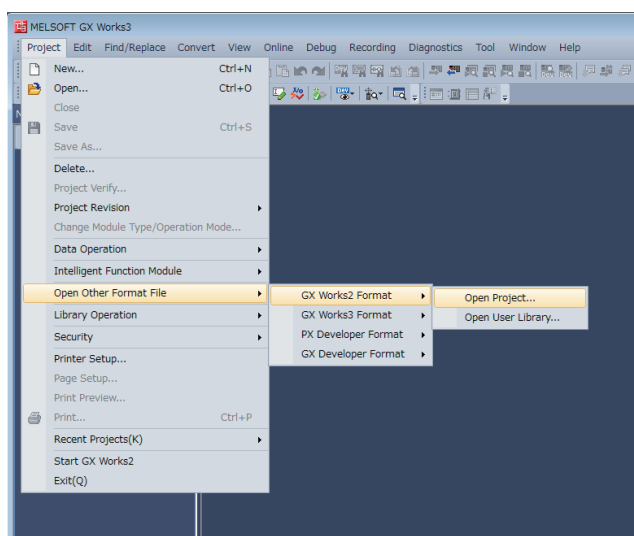

3. The following display is shown.

A selection screen of the following new module type and conversion method is shown.

Select the new module type and conversion method, and press the [Execute] button.

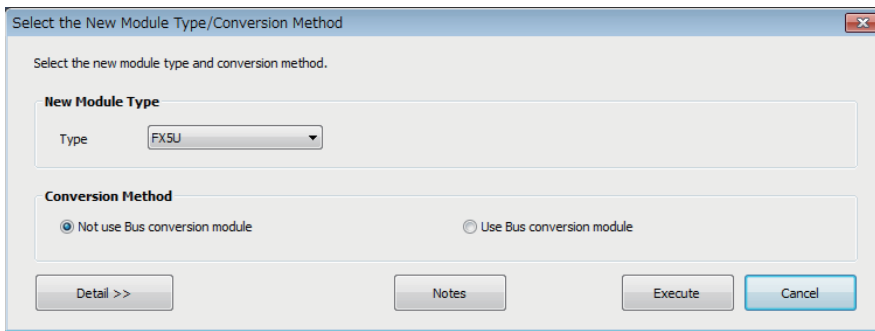

Point

- The display contents may vary depending on the version of the software.
- Precautions for the converted project are displayed. Please read carefully through the contents before use.

5

4. When conversion is completed, the following message is shown.

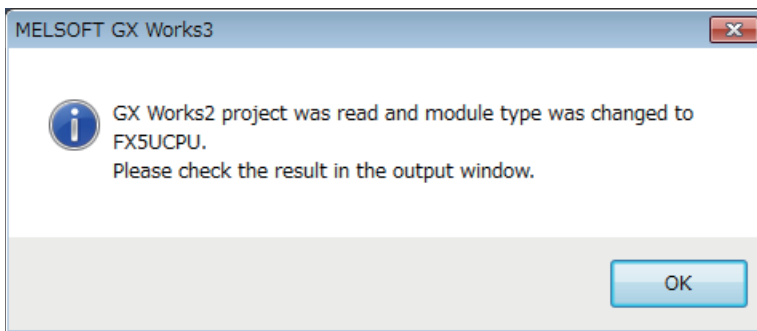

5. Check the contents of the model change result in the "Output window".

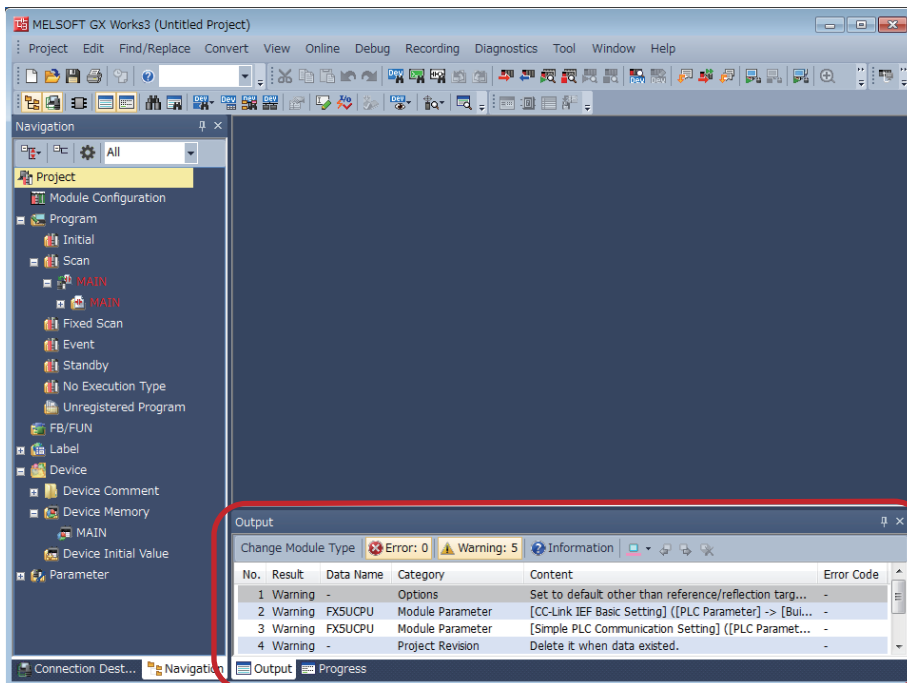

→ Output window

Precautions

- For GX Works3 versions earlier than 1.025B, the program must be changed from “No Execution Type”. (Change to Scan, etc.)
- When projects are converted, the program instructions and devices may be changed. Check the contents of the project. Parameters other than the network parameter of CC-Link*¹ will be deleted. Set the parameters if necessary.

*1 For the network parameter of CC-Link, refer to  Page 72 Precautions when Replacing the Parameters.

6. Set the model name of the CPU for the system parameter.

 [System Parameter] ⇒ [I/O Assignment Setting] ⇒ Model Name

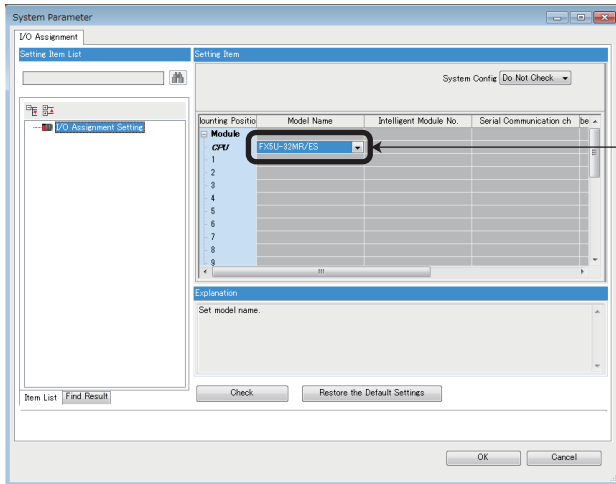

Set the model name of the CPU.

7. Perform conversion.

 [Convert] ⇒ [Rebuild All]

Precautions when Converting the Projects

- When converting FX3U projects using GX Works3, be careful because the program (instructions and devices) may be changed.
- When converting projects, the number of steps may increase and writing to the FX5U may be impossible. Check the number of steps after replacement.
- Characters used for the label name in GX Works2 may correspond to reserved words or illegal characters in GX Works3. In that case, change the label name.

For precautions regarding instruction and device conversion, refer to  Page 92 Instruction Replacement List.

Precautions when Replacing the Parameters

When converting FX3U projects to FX5U projects, the setting data of the parameters (PC parameters and network parameters) and special modules (intelligent function modules) will be deleted. Therefore, it is necessary to set the data with GX Works3 again.

Also, GX Works3 does not support the following parameters of the FX3U, so it is necessary to set these parameters with GX Works3 again.

- Network parameter (CC-Link)
- Intelligent function module parameter (AnyWireASLINK)

Precautions when Replacing Other Functions

Precautions when Using the High-speed Counters

When the high-speed counters (C235 to C255) are used with the FX3U, they will not operate just by switching to the FX5U. It is necessary to set the FX3 Series compatible high-speed counters and change the program by the parameter. For the setting procedure, refer to the following.

Parameter Setting Procedure of the FX3 Series Compatible High-speed Counters

1. Select "Long Counter Specification" at the specification for High-speed counters.

[Parameter] ⇒ [FX5UCPU] ⇒ [Module Parameter] ⇒ [High Speed I/O] ⇒ "Input Function" ⇒ "High Speed Counter" ⇒ "Detailed Setting" ⇒ "Other"

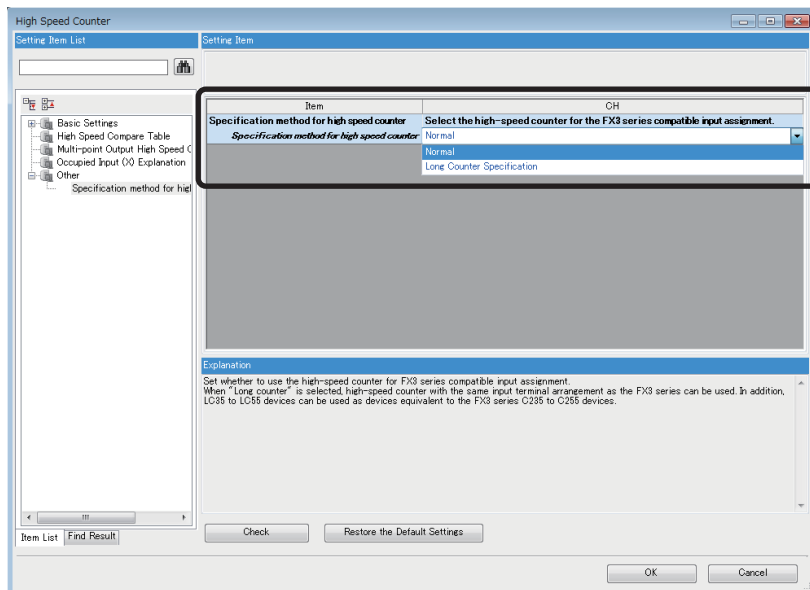

2. Set the function of the high-speed counters used with the FX3U.

Select the input comparison enable/disable of the counter device and preset input compatible with the FX3 Series, and select the control switch.

Item	CH1	CH2	
Use/Do Not Use Counter	Set whether to use counter or not.		
Use/Not Use	Enable	Disable	Disable
Counter device	Select the high-speed counter for the FX3 series compatible input assignment.		
Counter device	LC35 (Operation equivalent to C235)	LC36 (Operation equivalent to C236)	LC37 (Operation equivalent to C237)
Operation Mode	Set operation mode.		
Operation Mode	Normal Mode	Normal Mode	Normal Mode
Pulse Input Mode	Set pulse input mode.		
Pulse Input Mode	1-Phase 1 Input (S/W Up/Down Switch)	1-Phase 1 Input (S/W Up/Down Switch)	1-Phase 1 Input (S/W Up/Down Switch)
Preset Input	Set preset input.		
Preset Input Enable/Disable	Disable	Disable	Disable
Input logic	Positive Logic	Positive Logic	Positive Logic
Preset Value	0	0	0
Input Comparison Enable/Disable	Enable	Enable	Enable
Control Switch	Rising	Rising	Rising
Enable Input	Set enable input.		
Enable Input Enable/Disable	Disable	Disable	Disable
Input logic	Positive Logic	Positive Logic	Positive Logic
Ring Length Setting	Set ring length.		
Ring Length Enable/Disable	Disable	Disable	Disable
Ring Length	2147483648	2147483648	2147483648
Measurement Unit Time	Set the measurement unit time (ms) for the pulse density measurement mode and rotation speed measurement mode.		
Measurement Unit Time	1000 ms	1000 ms	1000 ms
Number of Pulses per Rotation	Set the number of pulses per rotation when using the rotation speed measurement mode.		
Number of Pulses per Rotation	1000 pulse	1000 pulse	1000 pulse

■ Changing the Program

Change the high-speed counter program by referring to the following program example.

[Example of program]

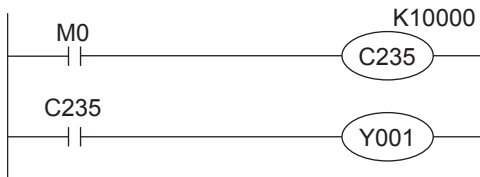

↓ Change the program.

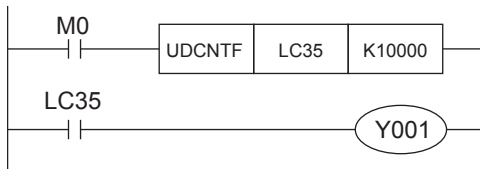

Precautions when Using the Routine Timer

When the routine timer (T192 to T199) is used with the FX3U, it will not operate just by switching to the FX5U. The routine timer must be set by the parameter. For the setting procedure, refer to the following.

■ Parameter Setting Procedure of the Routine Timer

Set the use of the routine timer and the leading device number.

🔗 [Parameter] ⇒ [FX5UCPU] ⇒ [CPU Parameter] ⇒ “Memory/Device Setting” ⇒ “Device/Label Memory Area Setting”

Item	Setting
Device/Label Memory Area Detailed Setting	
Device (high speed) Setting	<Detailed Setting>
Device (Standard) Setting	<Detailed Setting>
Latch type setting of the latch relay (L)	Latch (1)
Latch Label Latch Type	Latch (1)
Latch area of the latch label	Standard Latch Area
To use or not to use the routine timer of timer (T)	Use
Start device No. of routine timer of timer (T)	192
Index Register Setting	
Points Setting	
Total Points	24 Points
Index Register (Z)	20 Points

Explanation
 Set it to use the timer (T) as a routine timer.
 Routine timer is a timer works in subroutine or interrupt routine in which coil instruction is executed under a certain condition.

Serial Communication Channel Assignment (RS-485, RS-232C)

When the FX3U is replaced with the FX5U, the communication channel assignments that can be used change. Change the communication channels specified with instructions and parameter settings so that these channels match the specifications.

■FX3U communication channel assignment

A communication function expansion board and a special communication adapter can be used to connect up to two channels of serial ports.

The configurable combinations are shown below.

[Configuration example 1]

Using a communication function expansion board and a special communication adapter at the same time

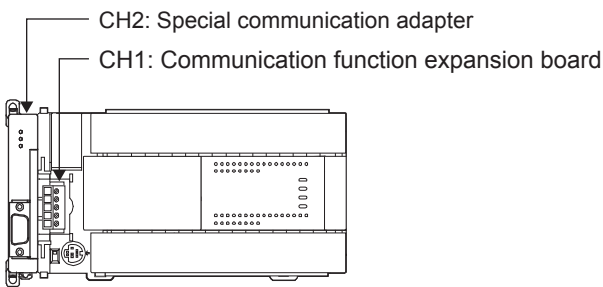

[Configuration example 2]

Using two special communication adapters

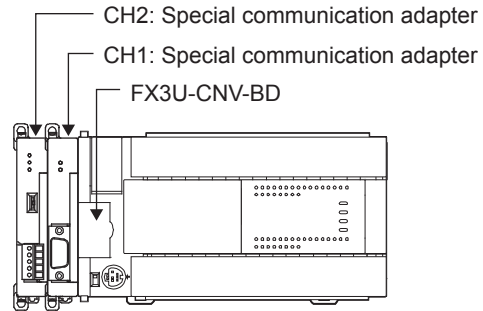

■FX5U communication channel assignment

The built-in RS-485 port, a communication board, and a communication adapter can be used to connect up to four channels of serial ports.

The communication channel assignments are fixed regardless of the system configuration.

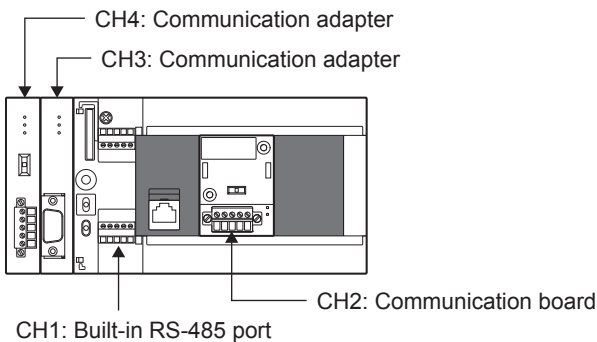

Ex.

When a communication function expansion board connected to the FX3U is replaced with an FX5U communication board, the communication channel changes from CH1 to CH2.

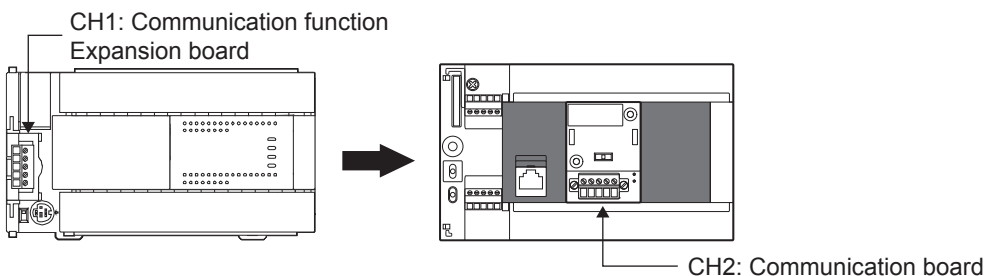

5.5 Replacement of the PLC

The main points to consider during replacement of the CPU module and extension modules are explained below.

For details of each item, check the reference pages in this document, and related manuals such as the PLC Hardware Manual and Programming Manual.

Device classification	Item	Operation content and points of attention	Reference page
CPU module	Reuse of the input/output wiring	Perform rewiring for the connection part of the terminal block type.	☞ Page 64
Other extension modules	Wiring to each module		
Verifying operation of the equipment	Operation and test of the PLC program	Operate the converted PLC program and hardware devices, and check and adjust the device function and operation timing. Be aware of the precautions described on the reference page for replacing the project, and check that the devices operate as they are designed.	☞ Page 70

6 Replacement from FX3UC to FX5UC

6.1 Outline

The FX5UC has compact and easy-to-use compatible extension modules, which makes downsizing of various devices possible. Connect to the FX5 and FX3 extension modules with the variety of conversion modules available.

The procedures and points for replacing an existing model with the FX5UC are shown below. Use this information to consider replacing existing models.

Points to Consider

- The “recommended substitute models” are described for individual FX3UC and extension modules that can be replaced by iQ-F Series models. According to usage and system configuration (connection status of the extension modules), and cases when the I/O numbers actually used are small, other models than the described “recommended substitute models” may be suitable for replacement.
- The recommended substitute models for extension modules and built-in batteries are described with those that can be connected to the FX5UC CPU module.
- Contents that require special caution when replacing each models are described in “Special notes”. Most recommended substitute models have various differences in the specifications other than those in “Special notes” such as the dimension becoming smaller than the current models. Therefore, when considering usage, please check not only the “Special notes” but also the details of each specification for the dimension and power specifications etc., in the manual.
- Based on the above conditions, “No recommended substitute models” is described for those without a recommended substitute model, but there are cases that can be replaced with an FX5UC system configuration according to usage and system configuration. Check the necessary functions and features when considering the replacement with FX5UC system configuration.

6.2 Replacement Procedure

The procedure for replacing the FX3UC with the FX5UC is shown below.

The successor model FX5UC is recommended when replacing from FX3UC.

1. Selection of the models

Select the substitute models.

☞ Page 78 Selection of Substitute Models

2. Conversion of the program

Convert the program used in FX3UC to be able to use in FX5UC.

☞ Page 85 Conversion of the Projects

3. Replacement to the substitute models

Replace the PLCs.

☞ Page 91 Replacement of the PLC

6.3 Selection of Substitute Models

Recommended Substitute Models

Recommended Substitute Models for CPU Modules

The recommended substitute models of FX5UC compatible with FX3UC are introduced below.

Please consider to replace the currently used CPU modules to the following recommended substitute models.

■List of recommended substitute models (CPU modules) for FX3UC → FX5UC replacement

FX3UC Series		Recommended substitute models		Special notes
Device name	Model name	Model name		
CPU module	FX3UC-16MR/D-T	FX5UC-32MR/DS-TS		The number of I/O increases in the recommended substitute models. The wiring must be replaced from the European terminal block to the spring clamp terminal block.
	FX3UC-16MT/D	FX5UC-32MT/D		
	FX3UC-32MT/D	FX5UC-32MT/D		
	FX3UC-64MT/D	FX5UC-64MT/D		
	FX3UC-96MT/D	FX5UC-96MT/D		
	FX3UC-16MR/DS-T	FX5UC-32MR/DS-TS		The number of I/O increases in the recommended substitute models. The wiring must be replaced from the European terminal block to the spring clamp terminal block.
	FX3UC-16MT/DSS	FX5UC-32MT/DSS		
	FX3UC-32MT/DSS	FX5UC-32MT/DSS		
	FX3UC-64MT/DSS	FX5UC-64MT/DSS		
	FX3UC-96MT/DSS	FX5UC-96MT/DSS		
	FX3UC-32MT-LT-2	No recommended substitute models		

Recommended Substitute Models for Extension Devices

The following list shows the extension devices that will be necessary to replace simultaneously when replacing the CPU module from FX3UC to FX5UC.

For products without a substitute model of the same function, check the contents described in the Special notes and please consider system reconfiguration.

■List of extension devices required to replace when replacing the CPU module from FX3UC to FX5UC

Extension device		Recommended substitute models	Special notes
Device name	Model name	Model name	
Extension I/O	FX2NC-16EX	FX5-C16EX/D	
	FX2NC-16EX-DS	FX5-C16EX/DS	
	FX2NC-16EX-T	FX5-C32EX/DS-TS	The number of I/O increases in the recommended substitute models. The wiring must be replaced from the European terminal block to the spring clamp terminal block.
	FX2NC-16EYT	FX5-C16EYT/D	
	FX2NC-16EYT-DSS	FX5-C16EYT/DSS	
	FX2NC-16EYR-T	FX5-C16EYR/D-TS	The wiring must be replaced from the European terminal block to the spring clamp terminal block.
	FX2NC-32EX	FX5-C32EX/D	
	FX2NC-32EX-DS	FX5-C32EX/DS	
	FX2NC-32EYT	FX5-C32EYT/D	
	FX2NC-32EYT-DSS	FX5-C32EYT/DSS	
	FX2N-8ER	FX5-16ER/ES	The number of I/O increases in the recommended substitute models.
	FX2N-8ER-ES/UL	FX5-16ER/ES	The number of I/O increases in the recommended substitute models.
	FX2N-8EX	FX5-8EX/ES	
	FX2N-8EX-ES/UL	FX5-8EX/ES	
	FX2N-8EX-UA1/UL	No recommended substitute models	
	FX2N-16EX	FX5-16EX/ES	
	FX2N-16EX-ES/UL	FX5-16EX/ES	
	FX2N-16EX-C	FX5-C16EX/D	
	FX2N-16EXL-C	No recommended substitute models	
	FX2N-8EYR	FX5-8EYR/ES	
	FX2N-8EYR-ES/UL	FX5-8EYR/ES	
	FX2N-8EYR-S-ES/UL	No recommended substitute models	
	FX2N-8EYT	FX5-8EYT/ES	
	FX2N-8EYT-ESS/UL	FX5-8EYT/ESS	
	FX2N-8EYT-H	No recommended substitute models	
	FX2N-16EYR	FX5-16EYR/ES	
	FX2N-16EYR-ES/UL	FX5-16EYR/ES	
	FX2N-16EYT	FX5-16EYT/ES	
	FX2N-16EYT-ESS/UL	FX5-16EYT/ESS	
	FX2N-16EYT-C	FX5-C16EYT/D	
FX2N-16EYS	No recommended substitute models		

Extension device		Recommended substitute models	Special notes
Device name	Model name	Model name	
Extension device	FX2NC-1HC	FX3U-2HC ^{*1}	The European terminal block must be replaced to the 40-pin connector.
	FX2N-4AD-TC	FX5-4AD-TC-ADP	The wiring must be replaced from the screw terminal block to the European terminal block.
	FX2N-4AD-PT	FX5-4AD-PT-ADP	
	FX3UC-4AD	FX5-4AD	The wiring must be replaced from the European terminal block to the spring clamp terminal block.
	FX2N-5A	FX5-4AD+FX5-4DA	The wiring must be replaced from the screw terminal block to the spring clamp terminal block.
	FX2N-2AD	FX5-4AD	The wiring must be replaced from the screw terminal block to the spring clamp terminal block.
	FX2N-8AD	FX5-8AD	The wiring must be replaced from the screw terminal block to the spring clamp terminal block.
	FX2N-2LC	FX5-4LC	The wiring must be replaced from the screw terminal block to the spring clamp terminal block.
	FX2N-2DA	FX5-4DA	The wiring must be replaced from the screw terminal block to the spring clamp terminal block.
	FX2N-1HC	FX3U-2HC ^{*1}	Replacement of the wiring from the screw terminal block to the connector is necessary.
	FX2N-10PG	FX5-20PG-D	Replacement is necessary due to the difference of the connector type.
	FX3U-20SSC-H	FX5-40SSC-S	Replacement is necessary due to the difference of the connector type for external input connection.
	FX2N-232IF	No recommended substitute models	
	FX2N-32CCL	FX5-CCL-MS	Set to the intelligent device station in the recommended substitute models. ^{*2}
	FX2N-64CL-M	No recommended substitute models	
	FX3U-ENET	No recommended substitute models	Ethernet port is built into FX5UC CPU module.
	FX3U-64DP-M	FX5-DP-M	
	FX3U-CAN	No recommended substitute models	
	FX3U-J1939	No recommended substitute models	
	FX2N-10GM	FX5-20PG-P	It cannot be used alone. Replacement is necessary due to the difference of the connector type.
FX2N-20GM	FX5-20PG-P	It cannot be used alone. Replacement is necessary due to the difference of the connector type.	
FX2N-1RM-SET(-E)	No recommended substitute models		
FX2N-32DP-IF(-D)	No recommended substitute models		
FX2N-64DNET	No recommended substitute models		
Expansion adapter	FX3U-232ADP(-MB)	FX5-232ADP	
	FX3U-485ADP(-MB)	FX5-485ADP	
	FX3U-ENET-ADP	No recommended substitute models	Ethernet port is built into FX5UC CPU module.
	FX3U-3A-ADP	FX5-4A-ADP	
	FX3U-4AD-ADP	FX5-4AD-ADP	
	FX3U-4DA-ADP	FX5-4DA-ADP	
	FX3U-4AD-PT-ADP	FX5-4AD-PT-ADP	
	FX3U-4AD-PTW-ADP	FX5-4AD-PT-ADP	
	FX3U-4AD-PNK-ADP	No recommended substitute models	
	FX3U-4AD-TC-ADP	FX5-4AD-TC-ADP	
	FX3U-CF-ADP	No recommended substitute models	Substituted by an SD memory card.

Extension device		Recommended substitute models	Special notes
Device name	Model name	Model name	
Option	FX2NC-CNV-IF	FX5-CNV-IFC	
	FX3UC-1PS-5V	FX5-C1PS-5V	
	FX3U-FLROM-16	No recommended substitute models	Substituted by an SD memory card.
	FX3U-FLROM-64	No recommended substitute models	Substituted by an SD memory card.
	FX3U-FLROM-64L	No recommended substitute models	Substituted by an SD memory card.
	FX3U-FLROM-1M	No recommended substitute models	Substituted by an SD memory card.
	FX-30P	No recommended substitute models	
	FX0N-30EC	FX5-30EC	
	FX0N-65EC	FX5-65EC	
	FX2N-CNV-BC	FX5-CNV-BC	

*1 It is possible to connect to the system of FX5UC CPU module by connecting a bus conversion module (FX5-CNV-BUSC or FX5-CNV-BUS).

*2 FX5-CCL-MS can be used as a master station.

Extension devices that can be reused when the CPU module is replaced to FX5UC

The following extension devices can be used by connecting a bus conversion module (FX5-CNV-BUSC or FX5-CNV-BUS) even when the CPU module is replaced (FX3UC → FX5UC).

■ Extension devices that can be used even when the CPU module is replaced from the FX3UC to FX5UC

Analog	Positioning	High-speed counter	Network	Terminal module ^{*1}	
FX3U-4AD FX3U-4DA FX3U-4LC	FX3U-1PG	FX3U-2HC	FX3U-16CCL-M ^{*2} FX3U-64CCL FX3U-128ASL-M ^{*2} FX3U-32DP	FX-16E-TB FX-32E-TB FX-16EX-A1-TB FX-16EYR-TB FX-16EYS-TB FX-16EYT-TB	FX-16E-TB/UL FX-32E-TB/UL FX-16EYR-ES-TB/UL FX-16EYS-ES-TB/UL FX-16EYT-ES-TB/UL FX-16EYT-ESS-TB/UL

*1 The terminal module can be used without connecting a bus conversion module.

*2 It is necessary to set the parameter with the PLC program.

Battery

The battery (FX3U-32BL) used in FX3UC can also be used with FX5UC.

Precautions Regarding the Hardware

Comparison of FX3UC and FX5UC and Precautions for Replacement

The following list shows precautions of the hardware. Check details in the manuals of each models when replacing.

■Difference and precautions regarding the main hardware of FX3UC and FX5UC

Item	Difference		Precautions
	FX3UC	FX5UC	
Extension of FX2N, FX2NC, FX3U, and FX3UC	Extension possible	Extension is possible only for certain modules. FX5-CNV-BUSC or FX5-CNV-BUS is required for extension.	Connection is not possible for some intelligent modules of FX3U.
Input hardware filter (When the digital filter is 0) <ul style="list-style-type: none"> • High-speed counter • Input interruption function • Pulse catch function 	X0 to X5: 5 μ s X6 and X7: 50 μ s X10 to X17: 200 μ s	<ul style="list-style-type: none"> ■In the case of FX5UC-32M X0 to X5: <ul style="list-style-type: none"> • ON: 2.5 μs or less • OFF: 2.5 μs or less X6 to X17: <ul style="list-style-type: none"> • ON: 30 μs or less • OFF: 50 μs or less ■In the case of FX5UC-64M and FX5UC-96M X0 to X7: <ul style="list-style-type: none"> • ON: 2.5 μs or less • OFF: 2.5 μs or less X10 to X17: <ul style="list-style-type: none"> • ON: 30 μs or less • OFF: 50 μs or less X20 or later: <ul style="list-style-type: none"> • ON: 50 μs or less • OFF: 150 μs or less 	Noises that were not detected by FX3UC may possibly be captured as an input. Take external measures against noise, or set an appropriate input response time parameter.
Input signal current	X0 to X5: 6 mA X6 and X7: 7 mA X10 or later: 5 mA	X0 to X17: 5.3 mA X20 or later: 4 mA	The input signal current has been lowered, so it is necessary to check the specification of the external devices when replacing.

External dimension drawing

There is some difference in the external dimension of FX3UC and the successor model FX5UC. Be careful when replacing the modules.

• FX3UC

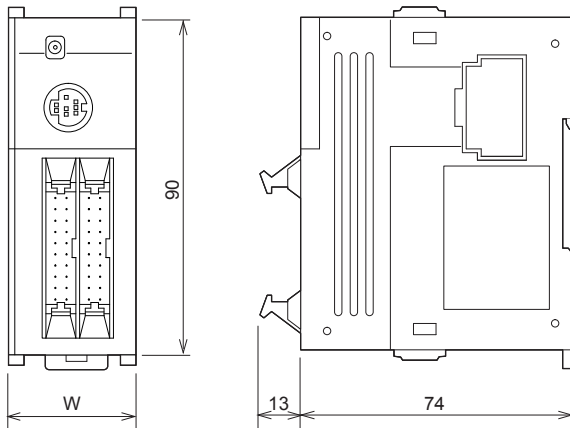

External color: Munsell 0.08GY/7.64/0.81

Unit: mm

35 mm width DIN rail can be installed

[Accessories]

FX2NC-100MPCB power cable

FX2NC-100BPCB power cable (only FX3UC-□MT/D)

Model name	W: mm	Weight: kg
FX3UC-16MT/D, DSS, FX3UC-32MT/D, DSS	34.0	Approx. 0.20
FX3UC-64MT/D, DSS	59.7	Approx. 0.30
FX3UC-96MT/D, DSS	85.4	Approx. 0.35

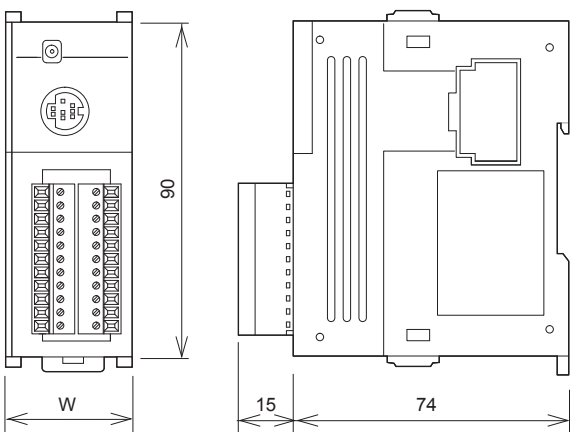

External color: Munsell 0.08GY/7.64/0.81

Unit: mm

35 mm width DIN rail can be installed

[Accessories]

FX2NC-100MPCB power cable

FX2NC-100BPCB power cable (only FX3UC-16MR/D-T)

Model name	W: mm	Weight: kg
FX3UC-16MR/D-T, FX3UC-16MR/DS-T	34.0	Approx. 0.25

• FX5UC

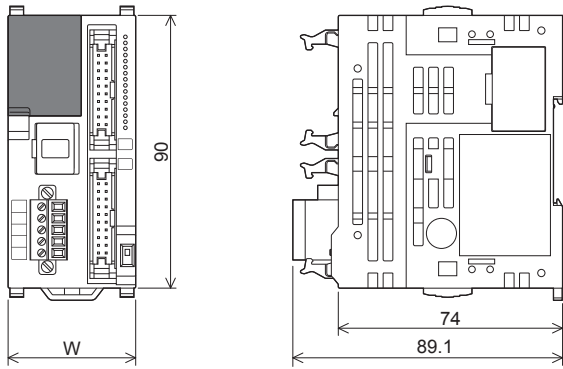

External color: Munsell 0.6B7.6/0.2
 Unit: mm
 35 mm width DIN rail can be installed

[Accessories]
 FX2NC-100MPCB power cable
 FX2NC-100BPCB power cable (only FX5UC-□MT/D)

Model name	W: mm	Weight: kg
FX5UC-32MT/D, DSS	42.1	Approx. 0.20
FX5UC-64MT/D, DSS	62.2	Approx. 0.30
FX5UC-96MT/D, DSS	82.3	Approx. 0.35

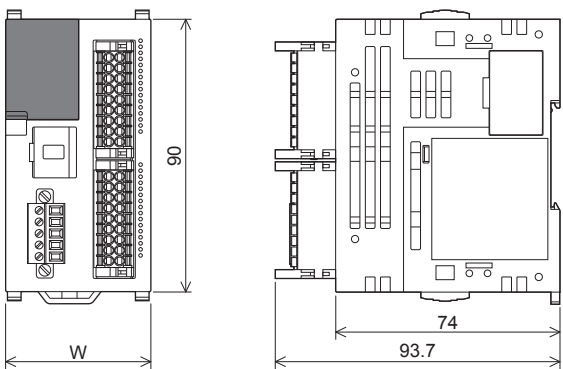

External color: Munsell 0.6B7.6/0.2
 Unit: mm
 35 mm width DIN rail can be installed

[Accessories]
 FX2NC-100MPCB power cable

Model name	W: mm	Weight: kg
FX5UC-32MR/DS-TS	68.2	Approx. 0.35

■ Cable sizes for European type terminal block

Suitable wiring and tightening torque are described below.

	Wire size for one wire	Wire size for two wires	Wire ferrule with insulation sleeve (wire size)	Tightening torque	Stripping dimensions of electric wire ends
Built-in RS-485 communication terminal block	AWG22 to AWG20	AWG22	AWG22 to AWG20	0.22 to 0.25 N·m	9 mm
FX3U-485ADP(-MB)				0.20 N·m	
FX5-485ADP					
FX5-4AD-ADP, FX5-4DA-ADP, FX5-4A-ADP, FX5-4AD-PT-ADP, FX5-4AD-TC-ADP					

6.4 Conversion of the Projects

When converting FX3UC projects to FX5UC projects, use GX Works3.

After converting the projects, it may be necessary to adjust the programs (instructions, devices) and parameters.

For the replacement of the SFC program, refer to Page 116 Conversion of the SFC Program.

Operation Method for Replacing Projects

To convert FX3UC projects to FX5UC projects, perform operations in GX Works3.

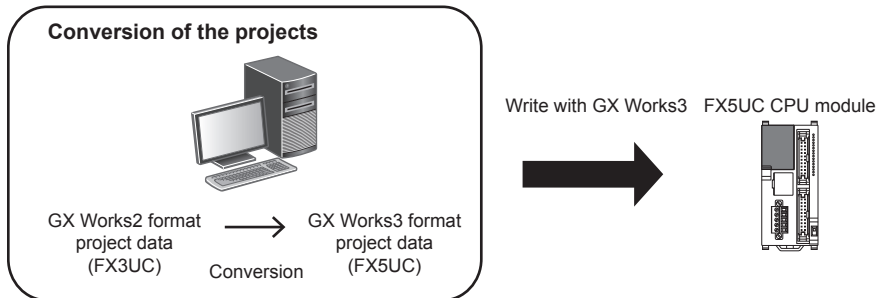

To convert the projects, install the engineering tool of the following version.

Engineering tool	Version	Remarks
GX Works3	1.020W or higher	—
GX Works2	1.519R or higher	Supplied with GX Works3.

Precautions

- To read projects of GX Works2 using GX Works3, convert beforehand using GX Works2, and then read the projects. Even for projects converted using GX Works2, conversion may not be performed according to the state of the project. If there is an error in the program, operation will be canceled.
- To read projects of GX Works2 using GX Works3, delete the security (user Management, data security setting) of GX Works2 beforehand and then read the projects. If the security is set to the GX Works2 project, read out will be canceled.
- To read projects of GX Works2 using GX Works3, administrator rights are required.

Operating procedure

1. Start up GX Works3.
2. Open the FX3UC project.

Select [Project] ⇒ [Open Other Format File] ⇒ [GX Works2 Format] ⇒ [Open Project] ⇒ Project (*.gwx).

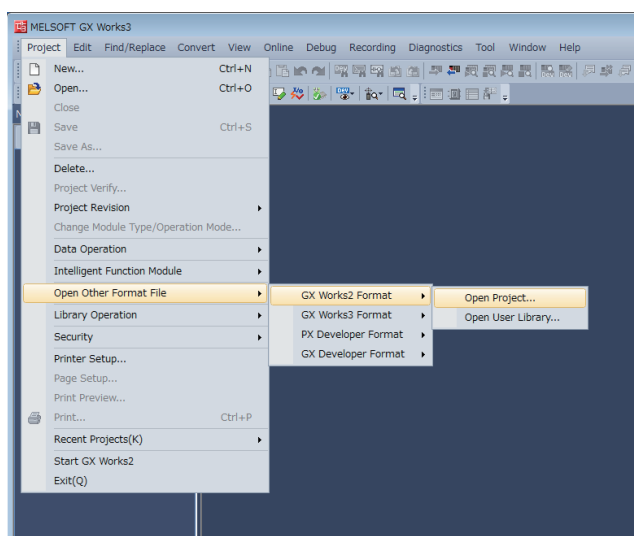

3. The following display is shown.

A selection screen of the following new module type and conversion method is shown.

Select the new module type and conversion method, and press the [Execute] button.

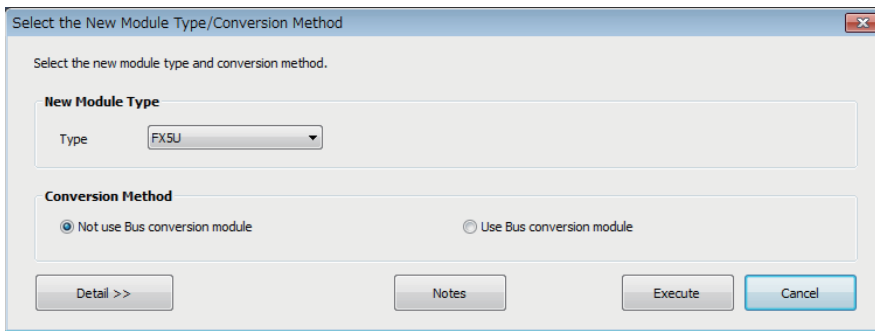

Point

- The display contents may vary depending on the version of the software.
- Precautions for the converted project are displayed. Please read carefully through the contents before use.

4. When conversion is completed, the following message is shown.

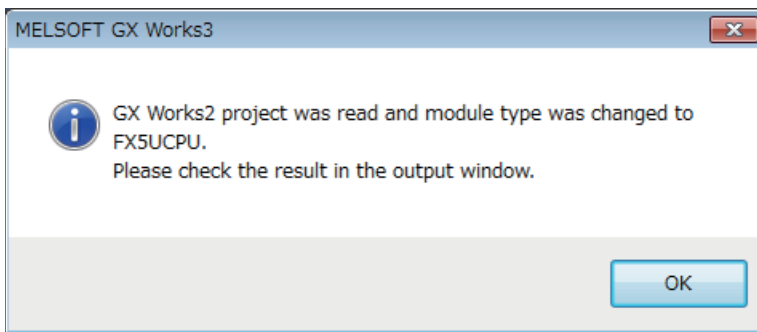

5. Check the contents of the model change result in the "Output window".

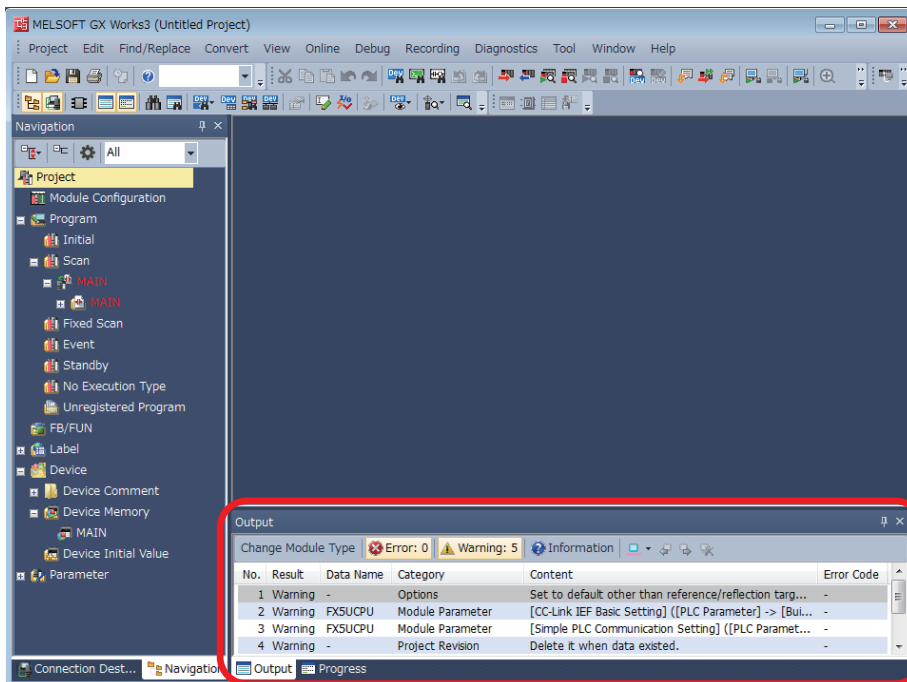

→ Output window

Precautions

- For GX Works3 versions earlier than 1.025B, the program must be changed from “No Execution Type”. (Change to Scan, etc.)
- When projects are converted, the program instructions and devices may be changed. Check the contents of the project. Parameters other than the network parameter of CC-Link*¹ will be deleted. Set the parameters if necessary.

*1 For the network parameter of CC-Link, refer to  Page 87 Precautions when Replacing the Parameters.

6. Set the model name of the CPU for the system parameter.

 [System Parameter] ⇒ [I/O Assignment Setting] ⇒ Model Name

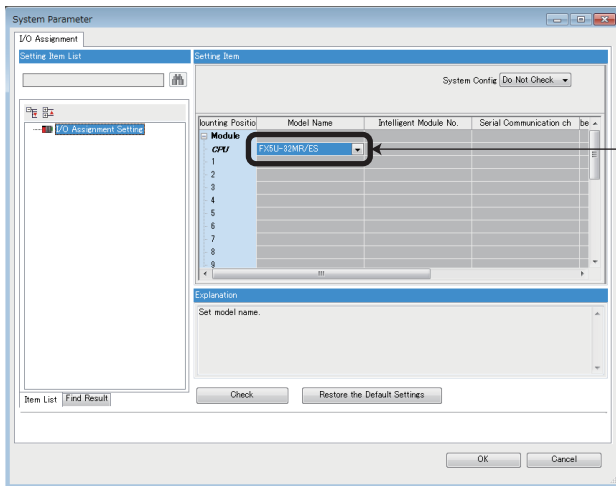

Set the model name of the CPU.

7. Perform conversion.

 [Convert] ⇒ [Rebuild All]

Precautions when Converting the Projects

- When converting FX3UC projects using GX Works3, be careful because the program (instructions and devices) may be changed.
- When converting projects, the number of steps may increase and writing to the FX5UC may be impossible. Check the number of steps after replacement.
- Characters used for the label name in GX Works2 may correspond to reserved words or illegal characters in GX Works3. In that case, change the label name.

For precautions regarding instruction and device conversion, refer to  Page 92 Instruction Replacement List.

Precautions when Replacing the Parameters

When converting FX3UC projects to FX5UC projects, the setting data of the parameters (PC parameters and network parameters) and special modules (intelligent function modules) will be deleted. Therefore, it is necessary to set the data with GX Works3 again.

Also, GX Works3 does not support the following parameters of the FX3UC, so it is necessary to set these parameters with GX Works3 again.

- Network parameter (CC-Link)
- Intelligent function module parameter (AnyWireASLINK)

Precautions when Replacing Other Functions

Precautions when Using the High-speed Counters

When the high-speed counters (C235 to C255) are used with the FX3UC, they will not operate just by switching to the FX5UC. It is necessary to set the FX3 Series compatible high-speed counters and change the program by the parameter. For the setting procedure, refer to the following.

Parameter Setting Procedure of the FX3 Series Compatible High-speed Counters

1. Select “Long Counter Specification” at the specification for High-speed counters.

[Parameter] ⇒ [FX5UCPU] ⇒ [Module Parameter] ⇒ [High Speed I/O] ⇒ “Input Function” ⇒ “High Speed Counter” ⇒ “Detailed Setting” ⇒ “Other”

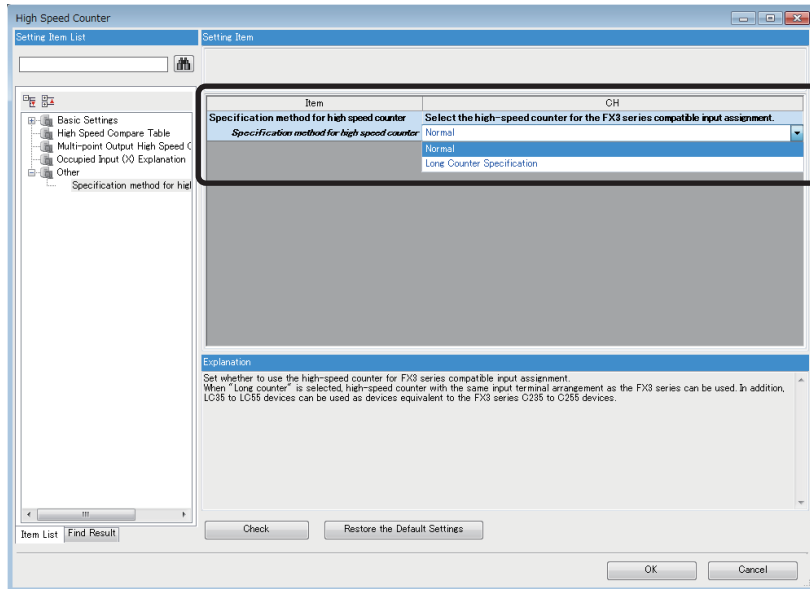

2. Set the function of the high-speed counters used with the FX3UC.

Select the input comparison enable/disable of the counter device and preset input compatible with the FX3 Series, and select the control switch.

Item	CH1	CH2	
Use/Do Not Use Counter	Set whether to use counter or not.		
Use/Not Use	Enable	Disable	Disable
Counter device	Select the high-speed counter for the FX3 series compatible input assignment.		
Counter device	LC35 (Operation equivalent to C235)	LC36 (Operation equivalent to C236)	LC37 (Operation equivalent to C237)
Operation Mode	Set operation mode.		
Operation Mode	Normal Mode	Normal Mode	Normal Mode
Pulse Input Mode	Set pulse input mode.		
Pulse Input Mode	1-Phase 1 Input (S/W Up/Down Switch)	1-Phase 1 Input (S/W Up/Down Switch)	1-Phase 1 Input (S/W Up/Down Switch)
Preset Input	Set preset input.		
Preset Input Enable/Disable	Disable	Disable	Disable
Input logic	Positive Logic	Positive Logic	Positive Logic
Preset Value	0	0	0
Input Comparison Enable/Disable	Enable	Enable	Enable
Control Switch	Rising	Rising	Rising
Enable Input	Set enable input.		
Enable Input Enable/Disable	Disable	Disable	Disable
Input logic	Positive Logic	Positive Logic	Positive Logic
Ring Length Setting	Set ring length.		
Ring Length Enable/Disable	Disable	Disable	Disable
Ring Length	2147483648	2147483648	2147483648
Measurement Unit Time	Set the measurement unit time (ms) for the pulse density measurement mode and rotation speed measurement mode.		
Measurement Unit Time	1000 ms	1000 ms	1000 ms
Number of Pulses per Rotation	Set the number of pulses per rotation when using the rotation speed measurement mode.		
Number of Pulses per Rotation	1000 pulse	1000 pulse	1000 pulse

■ Changing the Program

Change the high-speed counter program by referring to the following program example.

[Example of program]

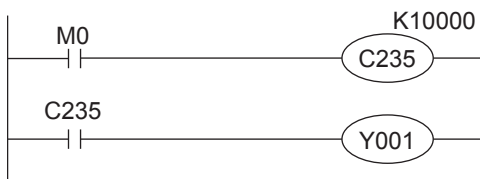

↓ Change the program.

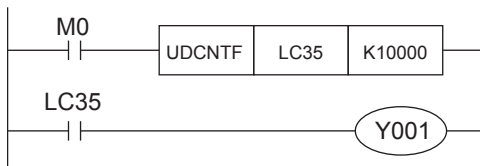

Precautions when Using the Routine Timer

When the routine timer (T192 to T199) is used with the FX3UC, it will not operate just by switching to the FX5UC. The routine timer must be set by the parameter. For the setting procedure, refer to the following.

■ Parameter Setting Procedure of the Routine Timer

Set the use of the routine timer and the leading device number.

[Parameter] ⇒ [FX5UCPU] ⇒ [CPU Parameter] ⇒ “Memory/Device Setting” ⇒ “Device/Label Memory Area Setting”

Item	Setting
Device/Label Memory Area Detailed Setting	
Device (high speed) Setting	<Detailed Setting>
Device (Standard) Setting	<Detailed Setting>
Latch type setting of the latch relay (L)	Latch (1)
Latch Label Latch Type	Latch (1)
Latch area of the latch label	Standard Latch Area
<i>Use or not to use the routine timer of timer (T)</i>	Use
Start device No. of routine timer of timer (T)	192
Index Register Setting	
Points Setting	
Total Points	24 Points
Index Register (Z)	20 Points

Explanation
 Set it to use the timer (T) as a routine timer.
 Routine timer is a timer works in subroutine or interrupt routine in which coil instruction is executed under a certain condition.

Serial Communication Channel Assignment (RS-485, RS-232C)

When the FX3UC is replaced with the FX5UC, the communication channel assignments that can be used change. Change the communication channels specified with instructions and parameter settings so that these channels match the specifications.

■FX3UC communication channel assignment

Special communication adapters can be used to connect up to two channels of serial ports. The configurable combination is shown below.

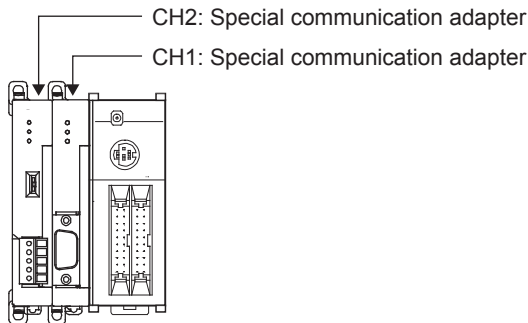

■FX5UC communication channel assignment

The built-in RS-485 port and communication adapters can be used to connect up to three channels of serial ports. The communication channel assignments are fixed regardless of the system configuration.

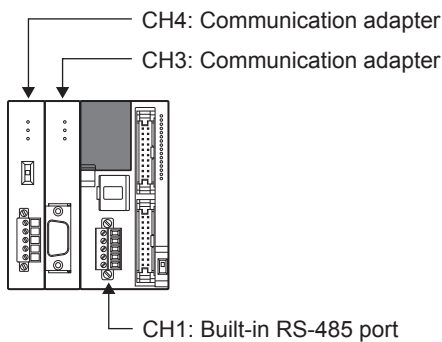

Ex.

When a special communication adapter connected to the FX3UC is replaced with an FX5UC communication adapter, the communication channel changes from CH1 to CH3.

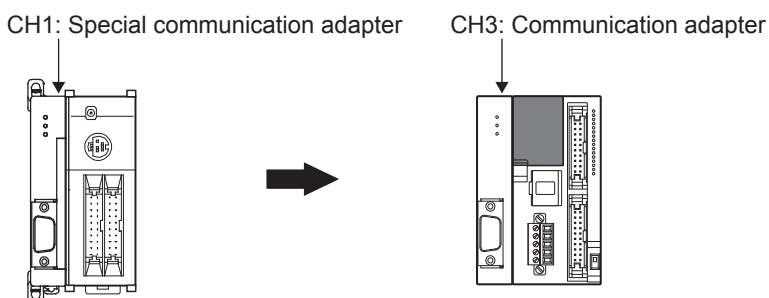

6.5 Replacement of the PLC

The main points to consider during replacement of the CPU module and extension devices are explained below.

For details of each item, check the reference pages in this document, and related manuals such as the PLC Hardware Manual and Programming Manual.

Device classification	Item	Operation content and points of attention	Reference page
CPU module	Connector connection of the input/output wiring	The input/output connector and 24 V DC connector types and signal names are the same for FX3UC and FX5UC. Reconnect the cable removed from FX3UC to FX5UC.	☞ Page 78
	Connector connection of the 24 V DC power cable	Perform rewiring for the connection part of the terminal block type.	
Other extension modules	Wiring to each module	The input/output connector and 24 V DC connector and signal names are the same for FX2NC and FX5UC. Reconnect the cable removed from FX2NC to FX5UC. Perform rewiring for the connection part of the terminal block type.	
Verifying operation of the equipment	Operation and test of the PLC program	Operate the converted PLC program and hardware devices, and check and adjust the device function and operation timing. Be aware of the precautions described on the reference page for replacing the project, and check that the devices operate as they are designed.	☞ Page 85

APPENDIX

When converting FX3S/FX3G/FX3U/FX3UC projects using GX Works3, be careful because the program (instructions and devices) may be changed.

When converting projects, the number of steps may increase and writing to the FX5 CPU module may be impossible. Check the number of steps after replacement.

Characters used for the label name in GX Works2 may correspond to reserved words or illegal characters in GX Works3. In that case, change the label name.

Appendix 1 Instruction Replacement List

Instruction Replacement List of Ladder Programs

■ Replaced instructions

The following instructions will be replaced to GX Works3 compatible instructions when converting the project.

FX3 Series	→	MELSEC iQ-F	Remarks
OUT T	→	OUT T/ST, OUTH T/ST, OUTHS T/ST <ul style="list-style-type: none"> When the timer is 1 ms, it will be replaced to the OUTHS T/ST instruction. When the timer is 10 ms, it will be replaced to the OUTH T/ST instruction. When the timer is 100 ms, it will be replaced to the OUT T/ST instruction. 	When a label is used instead of a timer device, the instructions will not be replaced.*1
INT	→	FLT2INT	—
INTP	→	FLT2INTP	—
DINT	→	FLT2DINT	—
DINTP	→	FLT2DINTP	—
RET	→	RETSTL	—
FLT	→	INT2FLT	—
FLTP	→	INT2FLTP	—
DFLT	→	DINT2FLT	—
DFLTP	→	DINT2FLTP	—
DTBL	→	TBL	—
SQR	→	SQRT	—
SER	→	SERMM	—
RAMP	→	RAMPF	—
SORT	→	SORTTBL	—
HEX	→	HEXA	—
SORT2	→	SORTTBL2	—
HOUR	→	HOURL	—
SQRP	→	SQRTP	—
DSQR	→	DSQRT	—
DSQRP	→	DSQRTP	—
SERP	→	SERMMP	—
DSER	→	DSERMM	—
DSERP	→	DSERMMP	—
HEXP	→	HEXAP	—
DSORT2	→	DSORTTBL2	—
DHOUR	→	DHOURL	—

FX3 Series	→	MELSEC IQ-F	Remarks
IVCK	→	IVCK	SM4095 is added to parameters of instructions. Change to an appropriate device or label.
IVDR	→	IVDR	
IVRD	→	IVRD	
IVWR	→	IVWR	
IVBWR	→	IVBWR	
IVMC	→	IVMC	
ADPRW	→	ADPRW	
PR	→	OUT SM4095	
COMRD	→	OUT SM4095	
COMRDP	→	OUT SM4095	
REFF	→	OUT SM4095	Correct the program to use REF instruction.
REFFP	→	OUT SM4095	Correct the program to use REFFP instruction.
DHSCT	→	OUT SM4095	Set the high-speed comparison table or multi-point output high-speed comparison table in the module parameter "High-speed I/O".
PLSR	→	OUT SM4095	Correct the program to use DRV1 instruction. Set the acceleration/ deceleration time specified by the PLSR instruction operand as the acceleration time and deceleration time of SD.
DPLSR	→	OUT SM4095	Correct the program to use DDRVI instruction. Set the acceleration/ deceleration time specified by the DPLSR instruction operand as the acceleration time and deceleration time of SD.
RS	→	OUT SM4095	Correct the program to use RS2 instruction.
VRRD	→	OUT SM4095	These instructions are not supported by MELSEC IQ-F. Therefore, it will be replaced to OUT SM4095.
VRRDP	→	OUT SM4095	
VRSC	→	OUT SM4095	
VRSCP	→	OUT SM4095	
ZRN	→	OUT SM4095	
DZRN	→	OUT SM4095	Correct the program to use DDSZR instruction. Use the same device for near-point dog signal and zero point signal of the DDSZR instruction, and set the zero point signal count start time to the rear end and the zero point signal count to 1.
HKY	→	OUT SM4095	Create the program using the input device (X).
DHKY	→	OUT SM4095	
TKY	→	OUT SM4095	
DTKY	→	OUT SM4095	
ARWS	→	OUT SM4095	
RD3A	→	OUT SM4095	
RD3AP	→	OUT SM4095	Correct the program to use FROMP instruction.
WR3A	→	OUT SM4095	Correct the program to use TO instruction.



FX3 Series	→	MELSEC iQ-F	Remarks
WR3AP	→	OUT SM4095	Correct the program to use TOP instruction.
LOADR	→	ERREAD ^{*2}	—
SAVER	→	OUT SM4095	Correct the program to use ERWRITE instruction.
INITR	→	OUT SM4095	Correct the program to use FMOV instruction. Correct the program to collectively initialize (clear to 0) the required number of points of the file register (R).
INITRP	→	OUT SM4095	Correct the program to use FMOV ^P instruction. Correct the program to collectively initialize (clear to 0) the required number of points of the file register (R).
LOGR	→	OUT SM4095	Use the data logging function.
LOGRP	→	OUT SM4095	Save the collected data to the SD memory card as a CSV file or binary file. *The data cannot be stored in the file register (R) or the extension file register (ER) in the SD memory card.
RWER	→	ERWRITE ^{*2}	—
RWERP	→	ERWRITE ^{*2}	—
INITER	→	ERINIT ^{*2}	—
INITERP	→	ERINIT ^{*2}	—
FLCRT	→	OUT SM4095	These instructions are not supported by MELSEC iQ-F. Therefore, it will be replaced to OUT SM4095.
FLDEL	→	OUT SM4095	
FLWR	→	OUT SM4095	
FLRD	→	OUT SM4095	
FLCMD	→	OUT SM4095	
FLSTRD	→	OUT SM4095	
ASC	→	OUT SM4095	

*1 For GX Works3 version 1.032J and later, the instructions will be replaced when a timer device is assigned to the global label.

*2 For GX Works3 version 1.038Q and earlier, the instructions will be replaced with OUT SM4095.

Precautions

When inline ST is used with the ladder program, instructions and devices can be replaced like ST programs. However, readout of the program may fail depending on the following conditions.

- If a syntax error exists
- If the program exceeds 2048 characters

If there is an instruction that is not supported by the MELSEC iQ-F Series in the program created using GX Works2, the instruction will be changed to the instruction using SM4095/SD4095.

Instruction Replacement List of Structured Ladder to FBD/LD

■ Replaced instructions

The following instructions will be replaced to GX Works3 compatible instructions when converting the project.

FX3 Series	→	MELSEC iQ-F	Remarks
OUT_C_32	→	OUT_C	—
OUT_T	→	OUT_T, OUTH, OUTHS • When the timer is 1 ms, it will be replaced to the OUTHS instruction. • When the timer is 10 ms, it will be replaced to the OUTH instruction. • When the timer is 100 ms, it will be replaced to the OUT_T instruction.	When a label is used instead of a timer device, the instructions will not be replaced.*1
RET	→	RETSTL	—
ROR	→	ROR_E	—
DROR	→	ROR_E	—
ROL	→	ROL_E	—
DROL	→	ROL_E	—
SQRP	→	SQRTP	—
DSQR	→	DSQRT	—
DSQRP	→	DSQRTP	—
FLT	→	INT2FLT	—
FLTP	→	INT2FLTP	—
DFLT	→	DINT2FLT	—
DFLTP	→	DINT2FLTP	—
SER	→	SERMM	—
SERP	→	SERMMP	—
DSER	→	DSERMM	—
DSERP	→	DSERMMP	—
RAMP	→	RAMPF	—
SORT	→	SORTTBL	—
HEX	→	HEXA	—
HEXP	→	HEXAP	—
INT	→	FLT2INT	—
INTP	→	FLT2INTP	—
DINT	→	FLT2DINT	—
DINTP	→	FLT2DINTP	—
SORT2	→	SORTTBL2	—
DSORT2	→	DSORTTBL2	—
DTBL	→	TBL	—
HOURL	→	HOURM	—
DHOUR	→	DHOURM	—
BK+	→	BKPLUS	—
BK+P	→	BKPLUSP	—
DBK+	→	DBKPLUS	—
DBK+P	→	DBKPLUSP	—
BK-	→	BKMINUS	—
BK-P	→	BKMINUSP	—
DBK-	→	DBKMINUS	—
DBK-P	→	DBKMINUSP	—
BKCMP=	→	BKCMP_EQ	—
BKCMP=P	→	BKCMP_EQP	—
DBKCMP=	→	DBKCMP_EQ	—
DBKCMP=P	→	DBKCMP_EQP	—
BKCMP>	→	BKCMP_GT	—
BKCMP>P	→	BKCMP_GTP	—
DBKCMP>	→	DBKCMP_GT	—

FX3 Series	→	MELSEC iQ-F	Remarks
DBKCMP>P	→	DBKCMP_GTP	—
BKCMPP<	→	BKCMPP_LT	—
BKCMPP<P	→	BKCMPP_LTP	—
DBKCMPP<	→	DBKCMPP_LT	—
DBKCMPP<P	→	DBKCMPP_LTP	—
BKCMPP<>	→	BKCMPP_NE	—
BKCMPP<>P	→	BKCMPP_NEP	—
DBKCMPP<>	→	DBKCMPP_NE	—
DBKCMPP<>P	→	DBKCMPP_NEP	—
BKCMPP<=	→	BKCMPP_LE	—
BKCMPP<=P	→	BKCMPP_LEP	—
DBKCMPP<=	→	DBKCMPP_LE	—
DBKCMPP<=P	→	DBKCMPP_LEP	—
BKCMPP>=	→	BKCMPP_GE	—
BKCMPP>=P	→	BKCMPP_GEP	—
DBKCMPP>=	→	DBKCMPP_GE	—
DBKCMPP>=P	→	DBKCMPP_GEP	—
\$+	→	STRINGPLUS	—
\$+P	→	STRINGPLUSP	—
\$MOV	→	STRINGMOV	—
\$MOV P	→	STRINGMOV P	—
LD=	→	LD_EQ	—
LDD=	→	LDD_EQ	—
LD>	→	LD_GT	—
LDD>	→	LDD_GT	—
LD<	→	LD_LT	—
LDD<	→	LDD_LT	—
LD<>	→	LD_NE	—
LDD<>	→	LDD_NE	—
LD<=	→	LD_LE	—
LDD<=	→	LDD_LE	—
LD>=	→	LD_GE	—
LDD>=	→	LDD_GE	—
AND=	→	AND_EQ	—
ANDD=	→	ANDD_EQ	—
AND>	→	AND_GT	—
ANDD>	→	ANDD_GT	—
AND<	→	AND_LT	—
ANDD<	→	ANDD_LT	—
AND<>	→	AND_NE	—
ANDD<>	→	ANDD_NE	—
AND<=	→	AND_LE	—
ANDD<=	→	ANDD_LE	—
AND>=	→	AND_GE	—
ANDD>=	→	ANDD_GE	—
OR=	→	OR_EQ	—
ORD=	→	ORD_EQ	—
OR>	→	OR_GT	—
ORD>	→	ORD_GT	—
OR<	→	OR_LT	—
ORD<	→	ORD_LT	—
OR<>	→	OR_NE	—
ORD<>	→	ORD_NE	—

FX3 Series	→	MELSEC iQ-F	Remarks	
OR<=	→	OR_LE	—	
ORD<=	→	ORD_LE	—	
OR>=	→	OR_GE	—	
ORD>=	→	ORD_GE	—	
IVCK	→	IVCK	SM4095 is added to parameters of instructions. Change to an appropriate device or label.	
IVDR	→	IVDR		
IVRD	→	IVRD		
IVWR	→	IVWR		
IVBWR	→	IVBWR		
IVMC	→	IVMC		
ADPRW	→	ADPRW		
LOADR	→	ERREAD*2		—
LOADRP	→	ERREAD*2		—
RWER	→	ERWRITE*2		—
RWERP	→	ERWRITE*2	—	
INITER	→	ERINIT*2	—	
INITERP	→	ERINIT*2	—	
SQR	→	SQRT_E	These instructions will be converted to standard functions.	
LEN	→	LEN_E		
RIGHT	→	RIGHT_E		
LEFT	→	LEFT_E		
LIMIT	→	LIMIT_E		
DLIMIT	→	LIMIT_E		
BOOL_TO_STR	→	BOOL_TO_STRING		—
BOOL_TO_STR_E	→	BOOL_TO_STRING_E	—	
INT_TO_STR	→	INT_TO_STRING	—	
INT_TO_STR_E	→	INT_TO_STRING_E	—	
DINT_TO_STR	→	DINT_TO_STRING	—	
DINT_TO_STR_E	→	DINT_TO_STRING_E	—	
REAL_TO_STR	→	REAL_TO_STRING	—	
REAL_TO_STR_E	→	REAL_TO_STRING_E	—	
STR_TO_BOOL	→	STRING_TO_BOOL	—	
STR_TO_BOOL_E	→	STRING_TO_BOOL_E	—	
STR_TO_INT	→	STRING_TO_INT	—	
STR_TO_INT_E	→	STRING_TO_INT_E	—	
STR_TO_DINT	→	STRING_TO_DINT	—	
STR_TO_DINT_E	→	STRING_TO_DINT_E	—	
STR_TO_REAL	→	STRING_TO_REAL	—	
STR_TO_REAL_E	→	STRING_TO_REAL_E	—	
STR_TO_TIME	→	STRING_TO_TIME	—	
STR_TO_TIME_E	→	STRING_TO_TIME_E	—	
TIME_TO_STR	→	TIME_TO_STRING	—	
TIME_TO_STR_E	→	TIME_TO_STRING_E	—	
MAXIMUM	→	MAX	—	
MAXIMUM_E	→	MAX_E	—	
MINIMUM	→	MIN	—	
MINIMUM_E	→	MIN_E	—	
LIMITATION	→	LIMIT	—	
LIMITATION_E	→	LIMIT_E	—	

*1 For GX Works3 version 1.032J and later, the instructions will be replaced when a timer device is assigned to the global label.

*2 These instructions are supported by GX Works3 version 1.040S and later.

■ Instructions that are not supported by GX Works3

The following instructions are not supported by GX Works3. The instructions are left as is when converting the projects, but an error will occur when compiling.

FX3 Series	→	MELSEC IQ-F	Remarks
CJ	→	CJ	—
CJP	→	CJP	—
CALL	→	CALL	—
CALLP	→	CALLP	—
SRET	→	SRET	—
IRET	→	IRET	—
FEND	→	FEND	—
REFF	→	REFF	Correct the program to use REF instruction.
REFFP	→	REFFP	Correct the program to use REFP instruction.
PLSR	→	PLSR	Correct the program to use DRV1 instruction. Set the acceleration/ deceleration time specified by the PLSR instruction operand as the acceleration time and deceleration time of SD.
DPLSR	→	DPLSR	Correct the program to use DDRV1 instruction. Set the acceleration/ deceleration time specified by the DPLSR instruction operand as the acceleration time and deceleration time of SD.
TKY	→	TKY	Create the program using the input device (X).
DTKY	→	DTKY	
HKY	→	HKY	
DHKY	→	DHKY	
ARWS	→	ARWS	
ASC	→	ASC	
PR	→	PR	—
RS	→	RS	Correct the program to use RS2 instruction.
VRRD	→	VRRD	—
VRRDP	→	VRRDP	—
VRSC	→	VRSC	—
VRSCP	→	VRSCP	—
ZRN	→	ZRN	Correct the program to use DSZR instruction. Use the same device for near-point dog signal and zero point signal of the DSZR instruction, and set the zero point signal count start time to the rear end and the zero point signal count to 1.
DZRN	→	DZRN	Correct the program to use DDSZR instruction. Use the same device for near-point dog signal and zero point signal of the DDSZR instruction, and set the zero point signal count start time to the rear end and the zero point signal count to 1.
RD3A	→	RD3A	Correct the program to use FROM instruction.
RD3AP	→	RD3AP	Correct the program to use FROMP instruction.
WR3A	→	WR3A	Correct the program to use TO instruction.

FX3 Series	→	MELSEC IQ-F	Remarks
WR3AP	→	WR3AP	Correct the program to use TOP instruction.
COMRD	→	COMRD	—
COMRDP	→	COMRDP	—
DHSCT	→	DHSCT	Set the high-speed comparison table or multi-point output high-speed comparison table in the module parameter "High-speed I/O".
SAVER	→	SAVER	Correct the program to use ERWRITE instruction.
INTR	→	INTR	Correct the program to use FMOV instruction. Correct the program to collectively initialize (clear to 0) the required number of points of the file register (R).
INTRP	→	INTRP	Correct the program to use FMOVP instruction. Correct the program to collectively initialize (clear to 0) the required number of points of the file register (R).
LOGR	→	LOGR	Use the data logging function.
LOGRP	→	LOGRP	Save the collected data to the SD memory card as a CSV or binary file. * The data cannot be stored in the file register (R) or the extension file register (ER) in the SD memory card.
FLCRT	→	FLCRT	—
FLDEL	→	FLDEL	—
FLWR	→	FLWR	—
FLRD	→	FLRD	—
FLCMD	→	FLCMD	—
FLSTRD	→	FLSTRD	—
GET_BIT_OF_INT	→	GET_BIT_OF_INT	—
GET_BIT_OF_INT_E	→	GET_BIT_OF_INT_E	—
SET_BIT_OF_INT	→	SET_BIT_OF_INT	—
SET_BIT_OF_INT_E	→	SET_BIT_OF_INT_E	—
CPY_BIT_OF_INT	→	CPY_BIT_OF_INT	—
CPY_BIT_OF_INT_E	→	CPY_BIT_OF_INT_E	—

A

Precautions

Even if the instructions are supported by GX Works3, a conversion error may occur due to the difference of the setting range of FX3S/FX3G/FX3U/FX3UC.

Instructions/FB/FUN that are not supported by the FBD/LD program will be undefined instructions/FB/FUN.

Instruction Replacement List of ST Programs

■ Replaced instructions

The following instructions will be replaced to GX Works3 compatible instructions when converting the project.

FX3 Series	→	MELSEC iQ-F	Remarks
OUT_T	→	OUT_T, OUTH, OUTHS <ul style="list-style-type: none"> When the timer is 1 ms, it will be replaced to the OUTHS instruction. When the timer is 10 ms, it will be replaced to the OUTH instruction. When the timer is 100 ms, it will be replaced to the OUT_T instruction. 	When a label is used instead of a timer device, the instructions will not be replaced.*1
SQRP	→	SQRTP	—
DSQR	→	DSQRT	—
DSQRP	→	DSQRTP	—
SER	→	SERMM	—
SERP	→	SERMMP	—
DSEr	→	DSERMM	—
DSErP	→	DSERMMP	—
RAMP	→	RAMPF	—
SORT	→	SORTTBL	—
HEX	→	HEXA	—
HEXP	→	HEXAP	—
SORT2	→	SORTTBL2	—
DSORT2	→	DSORTTBL2	—
HOUR	→	HOURM	—
DHOUR	→	DHOURM	—
IVCK	→	IVCK	SM4095 is added to parameters of instructions. Change to an appropriate device or label.
IVDR	→	IVDR	
IVRD	→	IVRD	
IVWR	→	IVWR	
IVBWR	→	IVBWR	
IVMC	→	IVMC	
ADPRW	→	ADPRW	
LOADR	→	ERREAD*2	
LOADRP	→	ERREAD*2	
RWER	→	ERWRITE*2	
RWERP	→	ERWRITE*2	
INITER	→	ERINIT*2	—
INITERP	→	ERINIT*2	—
SQR	→	SQRT_E	These instructions will be converted to standard functions.
LEN	→	LEN_E	
RIGHT	→	RIGHT_E	
LEFT	→	LEFT_E	
LIMIT	→	LIMIT_E	
DLIMIT	→	LIMIT_E	
BOOL_TO_STR	→	BOOL_TO_STRING	
BOOL_TO_STR_E	→	BOOL_TO_STRING_E	
INT_TO_STR	→	INT_TO_STRING	—
INT_TO_STR_E	→	INT_TO_STRING_E	—
DINT_TO_STR	→	DINT_TO_STRING	—
DINT_TO_STR_E	→	DINT_TO_STRING_E	—
REAL_TO_STR	→	REAL_TO_STRING	—
REAL_TO_STR_E	→	REAL_TO_STRING_E	—
STR_TO_BOOL	→	STRING_TO_BOOL	—

FX3 Series	→	MELSEC iQ-F	Remarks
STR_TO_BOOL_E	→	STRING_TO_BOOL_E	—
STR_TO_INT	→	STRING_TO_INT	—
STR_TO_INT_E	→	STRING_TO_INT_E	—
STR_TO_DINT	→	STRING_TO_DINT	—
STR_TO_DINT_E	→	STRING_TO_DINT_E	—
STR_TO_REAL	→	STRING_TO_REAL	—
STR_TO_REAL_E	→	STRING_TO_REAL_E	—
STR_TO_TIME	→	STRING_TO_TIME	—
STR_TO_TIME_E	→	STRING_TO_TIME_E	—
TIME_TO_STR	→	TIME_TO_STRING	—
TIME_TO_STR_E	→	TIME_TO_STRING_E	—
MAXIMUM	→	MAX	—
MAXIMUM_E	→	MAX_E	—
MINIMUM	→	MIN	—
MINIMUM_E	→	MIN_E	—
LIMITATION	→	LIMIT	—
LIMITATION_E	→	LIMIT_E	—

*1 For GX Works3 version 1.032J and later, the instructions will be replaced when a timer device is assigned to the global label.

*2 These instructions are supported by GX Works3 version 1.040S and later.

■ Instructions that are not supported by GX Works3

The following instructions are not supported by GX Works3. The instructions are left as is when converting the projects, but an error will occur when compiling.

FX3 Series	→	MELSEC iQ-F	Remarks
OUT_C_32	→	OUT_C_32	Correct the program to use OUT_C instruction.
IRET	→	IRET	—
FEND	→	FEND	—
DROR	→	DROR	Correct the program to use ROR_E instruction.
DROL	→	DROL	Correct the program to use ROL_E instruction.
FLT	→	FLT	Correct the program to use INT2FLT instruction.
FLTP	→	FLTP	Correct the program to use INT2FLTP instruction.
DFLT	→	DFLT	Correct the program to use DINT2FLT instruction.
DFLTP	→	DFLTP	Correct the program to use DINT2FLTP instruction.
REFF	→	REFF	Correct the program to use REF instruction.
REFFP	→	REFFP	Correct the program to use REFP instruction.
PLSR	→	PLSR	Correct the program to use DRVI instruction. Set the acceleration/ deceleration time specified by the PLSR instruction operand as the acceleration time and deceleration time of SD.
DPLSR	→	DPLSR	Correct the program to use DDRVI instruction. Set the acceleration/ deceleration time specified by the DPLSR instruction operand as the acceleration time and deceleration time of SD.

FX3 Series	→	MELSEC IQ-F	Remarks
TKY	→	TKY	Create the program using the input device (X).
DTKY	→	DTKY	
HKY	→	HKY	
DHKY	→	DHKY	
ARWS	→	ARWS	
ASC	→	ASC	
PR	→	PR	—
RS	→	RS	Correct the program to use RS2 instruction.
VRRD	→	VRRD	—
VRRDP	→	VRRDP	—
VRSC	→	VRSC	—
VRSCP	→	VRSCP	—
INT	→	INT	Correct the program to use FLT2INT instruction.
INTP	→	INTP	Correct the program to use FLT2INTP instruction.
DINT	→	DINT	Correct the program to use FLT2DINT instruction.
DINTP	→	DINTP	Correct the program to use FLT2DINTP instruction.
DTBL	→	DTBL	Correct the program to use TBL instruction.
ZRN	→	ZRN	Correct the program to use DSZR instruction. Use the same device for near-point dog signal and zero point signal of the DSZR instruction, and set the zero point signal count start time to the rear end and the zero point signal count to 1.
DZRN	→	DZRN	Correct the program to use DDSZR instruction. Use the same device for near-point dog signal and zero point signal of the DDSZR instruction, and set the zero point signal count start time to the rear end and the zero point signal count to 1.
RD3A	→	RD3A	Correct the program to use FROM instruction.
RD3AP	→	RD3AP	Correct the program to use FROMP instruction.
WR3A	→	WR3A	Correct the program to use TO instruction.
WR3AP	→	WR3AP	Correct the program to use TOP instruction.
COMRD	→	COMRD	—
COMRDP	→	COMRDP	—
DHSCT	→	DHSCT	Set the high-speed comparison table or multi-point output high-speed comparison table in the module parameter "High-speed I/O".
SAVER	→	SAVER	Correct the program to use ERWRITE instruction.
INITR	→	INITR	Correct the program to use FMOV instruction. Correct the program to collectively initialize (clear to 0) the required number of points of the file register (R).

FX3 Series	→	MELSEC iQ-F	Remarks
INITRP	→	INITRP	Correct the program to use FMOV instruction. Correct the program to collectively initialize (clear to 0) the required number of points of the file register (R).
LOGR	→	LOGR	Use the data logging function.
LOGRP	→	LOGRP	Save the collected data to the SD memory card as a CSV or binary file. * The data cannot be stored in the file register (R) or the extension file register (ER) in the SD memory card.
FLCRT	→	FLCRT	—
FLDEL	→	FLDEL	—
FLWR	→	FLWR	—
FLRD	→	FLRD	—
FLCMD	→	FLCMD	—
FLSTRD	→	FLSTRD	—
MOD	→	MOD	Dividing 16-bit binary data Correct the program to use ENO:=DIVISION(EN,s1,s2,d).

Precautions

Even if the instructions are supported by GX Works3, a conversion error may occur due to the difference of the setting range of FX3S/FX3G/FX3U/FX3UC.

When a character string constant is used in the GX Works2 program, be aware of the following points.

- When the character string is enclosed with a double quotation ("), it will be replaced with a single quotation (').
- When using a (') and (") in the character string constant of GX Works3, it must be input as (\$') and (\$").

Appendix 2 Precautions for Instruction Replacement

When converting the projects of the FX3 Series to MELSEC iQ-F projects, the instructions may be changed or correction required. The details are explained below.

Arguments

■Arguments of function with "_E"

For functions with "_E", the positions of the arguments are different between GX Works2 and GX Works3. Therefore the projects must be modified after conversion.

- GX Works2: EN is specified by the first argument and "ENO" is the return value.
- GX Works3: EN is specified by the first argument, ENO is specified by the second argument, and the result is the return value. (The value is the same as function without "_E".)

■Data type of arguments

The required data type of arguments for some instructions, functions, function blocks of GX Works2, and the required data type of arguments for the instructions, functions, function blocks of GX Works3 are different. Therefore, an error may occur because of data type mismatch when reusing the program of GX Works2. In that case, modify the instruction name or arguments.

Ex.

INC instruction

- When handling a value exceeding 32767 (maximum value of word [signed]), replace to "INC_U".
- When word [unsigned]/bit array [16-bit] type label is specified for the parameter, replace to "INC_U".

■The number and order of arguments

The number and order of arguments of some instructions in GX Works2 is different from those of GX Works3. In that case, modify the arguments.

Ex.

(D)TO instruction

- GX Works2: (S)(n1)(n2)(n3)
- GX Works3: (UnHn)(s1)(s2)(n)

When the order of the arguments in GX Works2 is 1, 2, 3, and 4, the order in GX Works3 is 2, 3, 1, and 4.

■Argument requiring multiple points

When using a label as an argument that requires multiple points, use an array label having at least as many elements as required of the argument.

Instructions/FB/FUN that are not supported by the MELSEC iQ-F Series

For the instructions/FB/FUN that are not supported by the MELSEC iQ-F Series, refer to the following manual to correct the program so that the instructions/FB/FUN will be equivalent to the one in the manual.

 MELSEC iQ-F FX5 Programming Manual (Instructions, Standard Functions/Function Blocks)

Instructions Requiring Special Action When Replacing Structured Ladder to FBD/LD

Instructions

The following instructions require action after the project conversion.

Instruction list			Action content
DHSCR	DSWAP	PLSV	The connecting position of the parameter is different from GX Works2. After replacing to FX5, select the appropriate instruction and perform "Edit"→"FB/FUN update" in the right-click menu, and then adjust the connecting position.
PLSY	DSWAPP	DPLSV	
DPLSY	DSZR	DRVI	
PWM	DVIT	DDRVI	
SWAP	DDVIT	DRVA	
SWAPP	DABS	DDRVA	
DHSCS_I			

Correction of structured ladder/FBD program

- The method of thinking for execution order is different for the GX Works2 structured ladder/FBD and GX Works3 FBD/LD language. Display the execution order and check the contents.
- The operation of the return element is different for the GX Works2 structured ladder/FBD and GX Works3 FBD/LD language. For details of the return element of GX Works3, refer to the following.

GX Works3 Operating Manual

- For the GX Works2 structured ladder/FBD and GX Works3 FBD/LD language, there are different cases in the input/output parameter numbers of the function parts/function block parts and the order. In this case, it will be displayed as an undefined FB/FUN. Select [Edit]→[FB/FUN update] to update the definition information, and correct the program.
- When the program is made to refer to a standard FB member in the GX Works2 structured ladder/FBD, a conversion error may occur after opening with GX Works3. In this case, check the member name and class of the standard FB, and correct the program.
- For the GX Works3 FBD/LD language, the input/output parameter of the function parts/function block elements can only be inverted. When elements other than the above are inverted for GX Works2 structured ladder/FBD, the connecting line of that element will be deleted. Correct the program so that the operation will be equal to GX Works2 structured ladder/FBD.
- For the GX Works3 FBD/LD language, the wired OR of the FBD elements are not supported. Correct the program so that the operation will be equal to GX Works2 structured ladder/FBD, or a conversion error will occur.
- When using the pointer branch instructions (CJ), jump, and sub routine program, a conversion error may occur. For details, refer to the following.

MELSEC iQ-F FX5 Programming Manual (Program Design)

- According to the difference of the GX Works2 structured ladder/FBD editor and GX Works3 FBD/LD editor, the layout of the program may change. Correct the layout appropriately.
- Ladder block label used in the GX Works2 structured ladder/FBD will be defined as a pointer type in local label.
- For GX Works3 FBD/LD language, the timer and counter device cannot reset by coil. Use the RST instruction.
- When the output of a function that executes on a pulse is connected to the input of another function, an error occurs. Receive the output by a device or label and then connect to the input.

Instructions Requiring Special Action When Replacing Instructions of ST programs

The following instructions require settings after the project conversion.

FX3 Series	→	MELSEC iQ-F	Action content
DHSCS_I	→	DHSCS_I	When an out of range "I" device is specified as the fourth parameter, it will be replaced with OUT instructions.

Appendix 3 Device Replacement List





The device lists when converting FX3S/FX3G/FX3U/FX3UC projects to MELSEC iQ-F projects are shown below. Actions such as replacing the device will be necessary according to the content of precautions.

FX3U, FX3UC → FX5U, FX5UC, and FX5UJ Device Replacement List









The device list when converting FX3U and FX3UC projects to MELSEC iQ-F (FX5U, FX5UC, and FX5UJ) projects is shown below.



Actions such as replacing the device will be necessary according to the content of precautions.

Device name		FX3U, FX3UC	After conversion to the FX5U, FX5UC, or FX5UJ	Precautions	
				In the case of FX5U and FX5UC	In the case of FX5UJ
Input relay		X0 to X367	X0 to X367	—	—
Output relay		Y0 to Y367	Y0 to Y367	—	—
Auxiliary relay	For general use	M0 to M499	M0 to M499	—	M384 to M499 are latch devices, so reset these devices as necessary. (MELSEC iQ-F FX5 Programming Manual (Instructions, Standard Functions/Function Blocks))
	For keep ^{*1}	M500 to M7679	M500 to M7679	—	—
	For special use	M8000 to M8511	SM0 to SM8511	Refer to Page 115 SM/SD Device Replacement.	Refer to Page 115 SM/SD Device Replacement.
State	For initial state (for general use)	S0 to S9	S0 to S9	When the device is used in the SFC program, it will be replaced with a step relay (BL□/S□) with block specification.	S0 to S499 are latch devices, so reset these devices as necessary. (MELSEC iQ-F FX5 Programming Manual (Instructions, Standard Functions/Function Blocks))
	For general use	S10 to S499	S10 to S499		
	For keep ^{*1}	S500 to S4095	S500 to S4095	—	—
	For annunciator (when using ANS instructions)	ANS S900 to S999	ANS F900 to F999	If necessary, replace the device number or change the device range. When the ANS instruction is not used, but these devices are used as an annunciator, these devices must be replaced with F devices. (MELSEC iQ-F FX5 User's Manual (Application))	If necessary, replace the device number. When the ANS instruction is not used, but these devices are used as an annunciator, these devices must be replaced with F devices. (MELSEC iQ-F FX5 User's Manual (Application))
	For annunciator (when not using ANS instructions)	S900 to S999	S900 to S999		

Device name		FX3U, FX3UC	After conversion to the FX5U, FX5UC, or FX5UJ	Precautions		
				In the case of FX5U and FX5UC	In the case of FX5UJ	
Timer	100 ms	OUT T T0 to T191	OUT T T0 to T191	—	—	
	100 ms Routine timer	OUT T T192 to T199	OUT T T192 to T199	The routine timer must be set by the parameter. (FX5U: Refer to  Page 74 Precautions when Using the Routine Timer. FX5UJ: Refer to  Page 89 Precautions when Using the Routine Timer.)	The routine timer must be set by the parameter. (Refer to  Page 60 Precautions when Using the Routine Timer.)	
	10 ms	OUT T T200 to T245	OUTH T T200 to T245	—	—	
	1 ms accumulated type	OUT T T246 to T249	OUTH S T ST0 to ST3	—	—	
	100 ms accumulated type	OUT T T250 to T255	OUT S T ST4 to ST9	—	—	
	1 ms	OUT T T256 to T511	OUTH S T T256 to T511	—	—	
	Contact	TS0 to TS245 and TS256 to TS511	TS0 to TS245 and TS256 to TS511	TS0 to TS245 and TS256 to TS511	—	—
			TS246 to TS255	STS0 to STS9	—	—
	Coil	TC0 to TC245 and TC256 to TC511	TC0 to TC245 and TC256 to TC511	TC0 to TC245 and TC256 to TC511	—	—
			TC246 to TC255	STC0 to STC9	—	—
	Current value	TN0 to TN245 and TN256 to TN511	TN0 to TN245 and TN256 to TN511	TN0 to TN245 and TN256 to TN511	—	—
			TN246 to TN255	STN0 to STN9	—	—
Counter	16-bit up counter for general use	C0 to C99	C0 to C99	—	C16 to C99 are latch devices, so reset these devices as necessary. ( MELSEC iQ-F FX5 Programming Manual (Instructions, Standard Functions/Function Blocks))	
	16-bit up counter for keep ^{*1}	C100 to C199	C100 to C199	—	—	
	32-bit bidirectional counter for general use	C200 to C219	LC0 to LC19	—	—	
	32-bit bidirectional counter for keep ^{*1}	C220 to C234	LC20 to LC34	—	—	
	Contact	CS0 to CS199 CS200 to CS234	CS0 to CS199	CS0 to CS199	—	—
			LCS0 to LCS34	—	—	
	Coil	CC0 to CC199 CC200 to CC234	CC0 to CC199	CC0 to CC199	—	—
			LCC0 to LCC34	—	—	
	Current value	CN0 to CN199 CN200 to CN234	CN0 to CN199	CN0 to CN199	—	—
			LCN0 to LCN34	—	—	



Device name		FX3U, FX3UC	After conversion to the FX5U, FX5UC, or FX5UJ	Precautions	
				In the case of FX5U and FX5UC	In the case of FX5UJ
High-speed counter	1-phase 1-count input	C235 to C245	C235 to C245	Setting of the FX3 Series compatibility assignment and replacement of the device number are necessary by the parameter. (FX5U: Refer to  Page 73 Precautions when Using the High-speed Counters. FX5UC: Refer to  Page 88 Precautions when Using the High-speed Counters.)	Setting of the FX3 Series compatibility assignment and replacement of the device number are necessary by the parameter. (Refer to  Page 59 Precautions when Using the High-speed Counters.)
	1-phase 2-count input	C246 to C250	C246 to C250		
	2-phase 2-count input	C251 to C255	C251 to C255		
	Contact	CS235 to CS255	CS235 to CS255	—	—
	Coil	CC235 to CC255	CC235 to CC255	—	—
	Current value	CN235 to CN255	CN235 to CN255	—	—
Data register	For general use	D0 to D199	D0 to D199	—	D128 to D199 are latch devices, so reset these devices as necessary. ( MELSEC iQ-F FX5 Programming Manual (Instructions, Standard Functions/Function Blocks))
	For keep ^{*1}	D200 to D7999	D200 to D7999	—	—
	For special use	D8000 to D8511	SD0 to SD8511	Refer to  Page 115 SM/SD Device Replacement.	Refer to  Page 115 SM/SD Device Replacement.
	File register	File register D1000 to D7999	—	Substitution is possible by using the device initial value function.	Substitution is possible by using the device initial value function.
Index register	16-bit Z device	Z0 to Z7	Z0 to Z7	—	—
	16-bit V device	V0 to V7	Z10 to Z17	—	—
	32-bit Z device (at modification of direct value)	Z0 to Z7	Z0 to Z7	If necessary, replace the direct value modification with an LZ device.	If necessary, replace the direct value modification with an LZ device.
Extension register	R0 to R32767	R0 to R32767	To latch data, the battery mode setting is necessary. ^{*2}	To latch data, check whether it can be supported by latch devices other than extension registers or by extension file registers.	
Extension file register	ER0 to ER32767	ER0 to ER32767	For GX Works3 versions earlier than 1.040S, the device number will be replaced with OUT SM4095.	—	
Pointer	Normal pointer	P0 to P4095 (except P63)	<ul style="list-style-type: none"> ■FX5U/FX5UC P0 to P4095 (except P63) ■FX5UJ P0 to P2047 (except P63) 	If necessary, replace the device number or change the device range. ( MELSEC iQ-F FX5 User's Manual (Application))	If necessary, replace the device number. ( MELSEC iQ-F FX5 User's Manual (Application))
	END pointer	P63	GOEND	—	—

Device name		FX3U, FX3UC	After conversion to the FX5U, FX5UC, or FX5UJ	Precautions	
				In the case of FX5U and FX5UC	In the case of FX5UJ
Interrupt pointer ^{*3}	Input interrupt (delay interrupt)	I00□ I10□ I20□ I30□ I40□ I50□	I0 to I5	Replaced as follows. ^{*4} I00□ → I0 I10□ → I1 I20□ → I2 I30□ → I3 I40□ → I4 I50□ → I5 □ = 1: Rise interrupt □ = 0: Fall interrupt When □ is 2 to 9, it will be replaced with P4095. The MELSEC iQ-F Series does not support the delay interrupt function. (There is no recommended substitute function.)	Replaced as follows. ^{*4} I00□ → I0 I10□ → I1 I20□ → I2 I30□ → I3 I40□ → I4 I50□ → I5 □ = 1: Rise interrupt □ = 0: Fall interrupt When □ is 2 to 9, it will be replaced with P4095. The MELSEC iQ-F Series does not support the delay interrupt function. (There is no recommended substitute function.)
	Timer interrupt	I6□□ I7□□ I8□□	I28 to I30	Replaced as follows. ^{*5} I6□□ → I28 I7□□ → I29 I8□□ → I30 □□ = 1 to 99: Execution interval (ms)	Replaced as follows. ^{*5} I6□□ → I28 I7□□ → I29 I8□□ → I30 □□ = 1 to 99: Execution interval (ms)
	Counter interrupt	I010 I020 I030 I040 I050 I060	I16 to I21	Replaced as follows. I010 → I16 I020 → I17 I030 → I18 I040 → I19 I050 → I20 I060 → I21	Replaced as follows. I010 → I16 I020 → I17 I030 → I18 I040 → I19 I050 → I20 I060 → I21
Module access device		Module number (0 to 7) BFM number (0 to 32766)	<ul style="list-style-type: none"> ■FX5U/FX5UC • Module number (1 to 16) • BFM number (0 to 65535) ■FX5UJ • Module number (1 to 8) • BFM number (0 to 65535) 	The conversion method can be selected. (FX5U: Refer to  Page 70 Operation Method for Replacing Projects. FX5UC: Refer to  Page 85 Operation Method for Replacing Projects.)	The conversion method can be selected. (Refer to  Page 56 Operation Method for Replacing Projects.)
Decimal constant	16-bit: K-32768 to K32767 32-bit: K-2147483648 to K2147483647	16-bit: K-32768 to K32767 32-bit: K-2147483648 to K2147483647	—	—	
Hexadecimal constant	16-Bit: H0 to HFFFF 32-Bit: H0 to HFFFFFFFF	16-Bit: H0 to HFFFF 32-Bit: H0 to HFFFFFFFF	—	—	
Real constant	-1.0×2 ¹²⁸ to -1.0×2 ⁻¹²⁶ , 0, 1.0×2 ⁻¹²⁶ to 1.0×2 ¹²⁸	-1.0×2 ¹²⁸ to -1.0×2 ⁻¹²⁶ , 0, 1.0×2 ⁻¹²⁶ to 1.0×2 ¹²⁸	—	—	
Character string constant	32 single-byte characters	255 single-byte characters	—	—	

*1 When the latch range of the device for keep of the FX3 Series is changed, if necessary, change the latch range or reset the devices. The changing of the latch range is only supported by the FX5U/FX5UC.

*2 Set the parameter with "Option Battery Setting" under [Parameter] ⇒ [FX5UCPU] ⇒ [CPU Parameter] ⇒ [Memory/Device Setting] ⇒ [Device/Label Memory Area Setting].

*3 Set the interrupt setting by the parameter accordingly.

*4 The parameter is reflected in [Parameter] ⇒ [FX5UCPU] or [FX5UJCPU] ⇒ [Module Parameter] ⇒ [High Speed I/O] ⇒ [Input Function] ⇒ [General/Interrupt/Pulse Catch].

Also, the parameter is reflected in [Module Parameter] ⇒ [Input Response Time Setting].

*5 The parameter is reflected in [Parameter] ⇒ [FX5UCPU] or [FX5UJCPU] ⇒ [CPU Parameter] ⇒ [Interrupt Settings] ⇒ [Fixed Interval Setting].







FX3G → FX5UJ Device Replacement List

The device list when converting FX3G projects to FX5UJ projects is shown below.

Actions such as replacing the device will be necessary according to the content of precautions.

Device name		FX3G	After conversion to the FX5UJ	Precautions	
Input relay		X0 to X177	X0 to X177	—	
Output relay		Y0 to Y177	Y0 to Y177	—	
Auxiliary relay	For general use	M0 to M383 M1536 to M7679	For general use: M0 to M383 For keep: M384 to M7679	M1536 to M7679 are latch devices, so reset these devices as necessary. (MELSEC iQ-F FX5 Programming Manual (Instructions, Standard Functions/Function Blocks))	
	For keep	M384 to M1535		—	
	For special use	M8000 to M8511	SM0 to SM8511	Refer to Page 115 SM/SD Device Replacement.	
State	For initial state (for keep)	S0 to S9	S0 to S9	—	
	For general use	S1000 to S4095	For keep: S1000 to S4095	S1000 to S4095 are latch devices, so reset these devices as necessary. (MELSEC iQ-F FX5 Programming Manual (Instructions, Standard Functions/Function Blocks))	
	For keep	S10 to S899	S10 to S899	—	
	For annunciator (when using ANS instructions)	ANS S900 to S999	ANS F900 to F999	If necessary, replace the device number. When the ANS instruction is not used, but these devices are used as an annunciator, these devices must be replaced with F devices. (MELSEC iQ-F FX5 User's Manual (Application))	
	For annunciator (when not using ANS instructions)	S900 to S999	S900 to S999		
Timer	100 ms	OUT T T0 to T191	OUT T T0 to T191	—	
	100 ms Routine timer	OUT T T192 to T199	OUT T T192 to T199	The routine timer must be set by the parameter. (Refer to Page 45 Precautions when Using the Routine Timer.)	
	10 ms	OUT T T200 to T245	OUTH T T200 to T245	—	
	1 ms accumulated type	OUT T T246 to T249	OUTH S T ST0 to ST3	—	
	100 ms accumulated type	OUT T T250 to T255	OUT S T ST4 to ST9	—	
	1 ms	OUT T T256 to T319	OUTH S T T256 to T319	—	
	Contact		TS0 to TS245, TS256 to TS319	TS0 to TS245, TS256 to TS319	—
			TS246 to TS255	STS0 to STS9	—
	Coil		TC0 to TC245, TC256 to TC319	TC0 to TC245, TC256 to TC319	—
			TC246 to TC255	STC0 to STC9	—
	Current value		TN0 to TN245, TN256 to TN319	TN0 to TN245, TN256 to TN319	—
			TN246 to TN255	STN0 to STN9	—

Device name		FX3G	After conversion to the FX5UJ	Precautions	
Counter	16-bit up counter for general use	C0 to C15	C0 to C15	—	
	16-bit up counter for keep	C16 to C199	C16 to C199	—	
	32-bit bidirectional counter for general use	C200 to C219	LC0 to LC19	—	
	32-bit bidirectional counter for keep	C220 to C234	LC20 to LC34	—	
	Contact		CS0 to CS199	CS0 to CS199	—
			CS200 to CS234	LCS0 to LCS34	—
	Coil		CC0 to CC199	CC0 to CC199	—
			CC200 to CC234	LCC0 to LCC34	—
Current value		CN0 to CN199	CN0 to CN199	—	
		CN200 to CN234	LCN0 to LCN34	—	
High-speed counter	1-phase 1-count input	C235 to C245	C235 to C245	Setting of the FX3 Series compatibility assignment and replacement of the device number are necessary by the parameter. (Refer to  Page 44 Precautions when Using the High-speed Counters.)	
	1-phase 2-count input	C246 to C250	C246 to C250		
	2-phase 2-count input	C251 to C255	C251 to C255		
	Contact	CS235 to CS255	CS235 to CS255	—	
	Coil	CC235 to CC255	CC235 to CC255	—	
	Current value	CN235 to CN255	CN235 to CN255	—	
Data register	For general use	D0 to D127 D1100 to D7999	For general use: D0 to D127	D1100 to D7999 are latch devices, so reset these devices as necessary. ( MELSEC iQ-F FX5 Programming Manual (Instructions, Standard Functions/Function Blocks))	
			For keep: D128 to D7999		
	For keep	D128 to D1099		—	
	For special use	D8000 to D8511	SD0 to SD8511	Refer to  Page 115 SM/SD Device Replacement.	
	File register	File register D1000 to D7999	—	Substitution is possible by using the device initial value function.	
Index register	16-bit Z device	Z0 to Z7	Z0 to Z7	—	
	16-bit V device	V0 to V7	Z10 to Z17	—	
	32-bit Z device (at modification of direct value)	Z0 to Z7	Z0 to Z7	If necessary, replace the direct value modification with an LZ device.	
Extension register		R0 to R23999	R0 to R23999	To latch data, check whether it can be supported by latch devices other than extension registers or by extension file registers.	
Extension file register		ER0 to ER23999	ER0 to ER23999	—	
Pointer	Normal pointer	P0 to P2047 (except P63)	P0 to P2047 (except P63)	If necessary, replace the device number. ( MELSEC iQ-F FX5 User's Manual (Application))	
	END pointer	P63	GOEND	—	

Device name		FX3G	After conversion to the FX5UJ	Precautions
Interrupt pointer* ¹	Input interrupt (delay interrupt)	I00□ I10□ I20□ I30□ I40□ I50□	I0 to I5	Replaced as follows.* ² I00□ → I0 I10□ → I1 I20□ → I2 I30□ → I3 I40□ → I4 I50□ → I5 □ = 1: Rise interrupt □ = 0: Fall interrupt When □ is 2 to 9, it will be replaced with P4095. The MELSEC iQ-F Series does not support the delay interrupt function. (There is no recommended substitute function.)
	Timer interrupt	I6□□ I7□□ I8□□	I28 to I30	Replaced as follows.* ³ I6□□ → I28 I7□□ → I29 I8□□ → I30 □□ = 1 to 99: Execution interval (ms)
	Counter interrupt	I010 I020 I030 I040 I050 I060	I16 to I21	Replaced as follows. I010 → I16 I020 → I17 I030 → I18 I040 → I19 I050 → I20 I060 → I21
Module access device		Module number (0 to 7) BFM number (0 to 32766)	Module number (1 to 8) BFM number (0 to 65535)	The conversion method can be selected. (Refer to  Page 41 Operation Method for Replacing Projects.)
Decimal constant		16-bit: K-32768 to K32767 32-bit: K-2147483648 to K2147483647	16-bit: K-32768 to K32767 32-bit: K-2147483648 to K2147483647	—
Hexadecimal constant		16-Bit: H0 to HFFFF 32-Bit: H0 to HFFFFFFFF	16-Bit: H0 to HFFFF 32-Bit: H0 to HFFFFFFFF	—
Real constant		-1.0×2 ¹²⁸ to -1.0×2 ⁻¹²⁶ , 0, 1.0×2 ⁻¹²⁶ to 1.0×2 ¹²⁸	-1.0×2 ¹²⁸ to -1.0×2 ⁻¹²⁶ , 0, 1.0×2 ⁻¹²⁶ to 1.0×2 ¹²⁸	—
Character string constant		32 single-byte characters	255 single-byte characters	—

*1 Set the interrupt setting by the parameter accordingly.

*2 The parameter is reflected in [Parameter] ⇒ [FX5UJCPU] ⇒ [Module Parameter] ⇒ [High Speed I/O] ⇒ [Input Function] ⇒ [General/Interrupt/Pulse Catch].

Also, the parameter is reflected in [Module Parameter] ⇒ [Input Response Time Setting].

*3 The parameter is reflected in [Parameter] ⇒ [FX5UJCPU] ⇒ [CPU Parameter] ⇒ [Interrupt Settings] ⇒ [Fixed Interval Setting].

FX3S → FX5S, FX5UJ, FX5U, and FX5UC Device Replacement List

The device list when converting FX3S projects to MELSEC iQ-F (FX5S, FX5UJ, FX5U, and FX5UC) projects is shown below. Actions such as replacing the device will be necessary according to the content of precautions.

Device name		FX3S	After conversion to the FX5S, FX5UJ, FX5U, or FX5UC	Precautions
Input relay		X0 to X17	X0 to X17	—
Output relay		Y0 to Y15	Y0 to Y15	—
Auxiliary relay	For general use	M0 to M383, M512 to M1535	M0 to M383, M512 to M1535	—
	For keep	M384 to M511	M384 to M511	—
	For special use	M8000 to M8511	SM0 to SM8511	☞ Page 115 SM/SD Device Replacement
State	For initial state (for keep)	S0 to S9	S0 to S9	<p>■For FX5U and FX5UC When the device is used in the SFC program, it will be replaced with a step relay (BL□\S□) with block specification.</p> <p>■For FX5UJ S0 to S255 are latch devices, so reset these devices as necessary. (☞MELSEC iQ-F FX5 Programming Manual (Instructions, Standard Functions/Function Blocks))</p>
	For general use	S128 to S255	S128 to S255	
	For keep	S10 to S127	S10 to S127	
Timer	100 ms	OUT T T0 to T31	OUT T T0 to T31	—
	100 ms/10 ms	OUT T T32 to T62	OUT T T32 to T62	If T32 to T62 are used when the timer is 10 ms, these devices must be replaced with the OUTH instruction.
	1ms	OUT T T63 to T127	OUTHS T T63 to T127	—
	1ms accumulated type	OUT T T128 to T131	OUTHS ST ST0 to ST3	—
	100 ms accumulated type	OUT T T132 to T137	OUT ST ST4 to ST9	—
	Contact	TS0 to TS245, TS256 to TS511	TS0 to TS245, TS256 to TS511	—
		TS246 to TS255	STS0 to STS9	—
	Coil	TC0 to TC245, TC256 to TC511	TC0 to TC245, TC256 to TC511	—
		TC246 to TC255	STC0 to STC9	—
	Current value	TN0 to TN245, TN256 to TN511	TN0 to TN245, TN256 to TN511	—
TN246 to TN255		STN0 to STN9	—	
Counter	16-bit up counter for general use	C0 to C15	C0 to C15	—
	16-bit up counter for keep	C16 to C31	C16 to C31	—
	32-bit bidirectional counter for general use	C200 to C234	LC0 to LC34	—
	Contact	CS0 to CS199	CS0 to CS199	—
		CS200 to CS234	LCS0 to LCS34	—
	Coil	CC0 to CC199	CC0 to CC199	—
		CC200 to CC234	LCC0 to LCC34	—
	Current value	CN0 to CN199	CN0 to CN199	—
CN200 to CN234		LCN0 to LCN34	—	

Device name		FX3S	After conversion to the FX5S, FX5UJ, FX5U, or FX5UC	Precautions	
High-speed counter	1-phase 1-count input	C235 to C245	C235 to C245	Setting of the FX3 Series compatibility assignment and replacement of the device number are necessary by the parameter.	
	1-phase 2-count input	C246 to C250	C246 to C250		
	2-phase 2-count input	C251 to C255	C251 to C255		
	Contact	CS235 to CS255	CS235 to CS255		—
	Coil	CC235 to CC255	CC235 to CC255		—
	Current value	CN235 to CN255	CN235 to CN255		—
Data register	For general use	D0 to D127, D256 to D2999	D0 to D127, D256 to D2999	—	
	For keep	D128 to D255	D128 to D255	—	
	For special use	D8000 to D8511	SD0 to SD8511	☞ Page 115 SM/SD Device Replacement	
	File register	D1000 to D2999	—	Substitution is possible by using the device initial value function.	
Index register	16-bit Z device	Z0 to Z7	Z0 to Z7	—	
	16-bit V device	V0 to V7	Z10 to Z17	—	
	32-bit Z device (at modification of direct value)	Z0 to Z7	Z0 to Z7	If necessary, replace the direct value modification with an LZ device.	
Pointer	Normal pointer	P0 to P255 (except P63)	P0 to P255 (except P63)	If necessary, replace the device number or change the device range. (☞ MELSEC iQ-F FX5 User's Manual (Application))	
	END pointer	P63	GOEND	—	
Interrupt pointer ^{*1}	Input interrupt (delay interrupt)	I00□ I10□ I20□ I30□ I40□ I50□	I0 to I5	Replaced as follows. ^{*2} I00□→I0 I10□→I1 I20□→I2 I30□→I3 I40□→I4 I50□→I5 □ = 1: Rise interrupt □ = 0: Fall interrupt When □ is 2 to 9, it will be replaced with P4095.	
	Timer interrupt	I6□□ I7□□ I8□□	I28 to I30	Replaced as follows. ^{*3} I6□□→I28 I7□□→I29 I8□□→I30 □□ = 1 to 99: Timer value	
Decimal constant		16-bit: K-32768 to K32767 32-bit: K-2147483648 to K2147483647	16-bit: K-32768 to K32767 32-bit: K-2147483648 to K2147483647	—	
Hexadecimal constant		16-bit: H0 to HFFFF 32-bit: H0 to HFFFFFFFF	16-bit: H0 to HFFFF 32-bit: H0 to HFFFFFFFF	—	
Real constant		-1.0×2 ¹²⁸ to -1.0×2 ⁻¹²⁶ , 0, 1.0×2 ⁻¹²⁶ to 1.0×2 ¹²⁸	-1.0×2 ¹²⁸ to -1.0×2 ⁻¹²⁶ , 0, 1.0×2 ⁻¹²⁶ to 1.0×2 ¹²⁸	—	

*1 Set the interrupt setting by the parameter accordingly.

*2 The parameter is reflected in [Parameter] ⇒ Module model name ⇒ [Module Parameter] ⇒ [High Speed I/O] ⇒ [Input Function] ⇒ [General/Interrupt/Pulse Catch].

Also, the parameter is reflected in [Module Parameter] ⇒ [Input Response Time Setting].

*3 The parameter is reflected in [Parameter] ⇒ Module model name ⇒ [CPU Parameter] ⇒ [Interrupt Settings] ⇒ [Fixed Scan Interval Setting].

Appendix 4 Precautions for Device Replacement

Precautions for Device Replacement

When the firmware version of FX5U/FX5UC CPU module is earlier than 1.220 and the version of GX Works3 is earlier than 1.070Y or when FX5UJ CPU module is used, the S devices cannot be index-modified. Replace as follows. For other precautions, refer to MELSEC iQ-F FX5 Programming Manual (Program Design).

- When the S device without state management has its index modified, replace to M device to use.
- When the S device used for state management has its index modified and used for the ZRST instructions, program the ZRST instructions for each batch-clear pattern.

For GX Works3 whose version is earlier than 1.030G, the assigned device of the global label cannot be read out.

- Information of the assigned device in GX Works2 is input in the comment field. Refer to the comment field to assign the device again.
- When special M and special D have been assigned, they will be replaced and assigned to SM and SD.

If S device is set to the device memory data or device initial data created using GX Works2, it will be deleted.

If there is a device that is not supported by the MELSEC iQ-F Series in the program created using GX Works2, the device will be changed to SM4095/SD4095.

The default value is set to the parameter setting of device points.

SM/SD Device Replacement

Devices, M8000 and later and D8000 and later of FX3S/FX3G/FX3U/FX3UC, will be changed to devices, SM8000 and later and SD8000 and later. However, some devices may be changed depending on the version of GX Works3. For details, refer to the following.

FX3S/ FX3G/ FX3U/ FX3UC	After replacing to MELSEC iQ-F		FX3S/ FX3G/ FX3U/ FX3UC	After replacing to MELSEC iQ-F	
	GX Works3 version 1.032J and earlier	GX Works3 version 1.035M and later		GX Works3 version 1.032J and earlier	GX Works3 version 1.035M and later
M8004	SM8004	SM0	M8240	SM8240	SM4585
M8009	SM8009	SM0	M8241	SM8241	SM4580
M8061	SM8061	SM0	M8242	SM8242	SM4582
M8064	SM8064	SM0	M8243	SM8243	SM4584
M8065	SM8065	SM0	M8244	SM8244	SM4580
M8066	SM8066	SM0	M8245	SM8245	SM4582
M8091	SM8091	SM701	M8318	SM8318	SM0
M8131	SM8131	SM5001	M8489	SM8489	SM0
M8133	SM8133	SM5001	D8004	SD8004	SD0
M8138	SM8138	SM5001	D8009	SD8009	SD0
M8139	SM8139	SM5000	D8061	SD8061	SD0
M8165	SM8165	SM703	D8064	SD8064	SD0
M8235	SM8235	SM4580	D8065	SD8065	SD0
M8236	SM8236	SM4581	D8066	SD8066	SD0
M8237	SM8237	SM4582	D8101	SD8101	SD8001
M8238	SM8238	SM4583	D8166	SD8166	SD83
M8239	SM8239	SM4584	D8489	SD8489	SD0

Appendix 5 Conversion of the SFC Program

Below are described the procedure and precautions for converting FX3U/FX3UC projects created with the SFC program into FX5U/FX5UC projects.

After converting the projects, it may be necessary to adjust the programs (instructions, devices) and parameters.

Point

This chapter describes the SFC program operations and specifications. For information not contained in this chapter, refer to the following.

 GX Works3 Operating Manual

 MELSEC iQ-F FX5 User's Manual (Application)

 MELSEC iQ-F FX5 Programming Manual (Program Design)

Differences in Specifications After Replacement

The differences in specifications of the SFC program between FX3U/FX3UC and FX5U/FX5UC are shown below.

Classification	Item		FX3U/FX3UC	FX5U/FX5UC
SFC program	Number of simultaneously activated steps	In 1 block	512 steps	128 steps ^{*1}
		Whole system	4096 steps	128 steps ^{*2}
SFC operation	SFC operation mode when power is turned off and on or reset	Resume start	○	○ ^{*3}
Transition control	Transition condition	Reset jump	○	× ^{*4}
SFC control instructions	Execution of SFC control instructions in interrupt program		○	×
Monitor	Monitoring by special device	SM8046 (STL operation)	○	×
		SM8047 (STL monitor enabled), SD8040 to SD8047 (ON state numbers)	○	×

*1 When the number of steps exceeds 128, a stop error (31B3H) will occur.

*2 When the number of steps exceeds 128, a stop error (31B4H) will occur.

*3 After replacement, the setting is "Initial Start". To use "Resume Start", it is necessary to change the parameter and install the optional battery.

*4 If a reset jump is contained in an FX3U/FX3UC project, the reset jump will be replaced with an end step when the project is replaced with an FX5U/FX5UC project.

Operation Method for Replacing Projects

To convert FX3U/FX3UC projects to FX5U/FX5UC projects, perform operations in GX Works3.

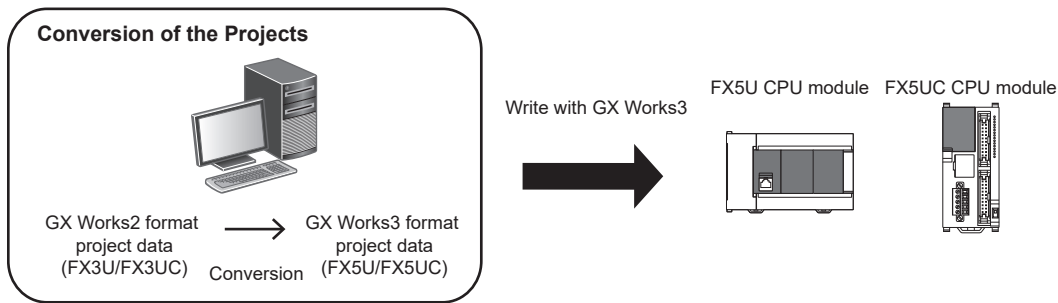

The SFC program is compatible with the following versions.

Item	Specification
Compatible CPU module	FX5U/FX5UC CPU module (Ver. 1.220 or later)
Compatible engineering tool	GX Works3 (Ver. 1.070Y or later)*1

*1 To convert FX3U/FX3UC projects created with the SFC program into FX5U/FX5UC projects, it is necessary to install GX Works2 whose version is 1.585K or later.

Precautions

- To read projects of GX Works2 using GX Works3, convert beforehand using GX Works2, and then read the projects. Even for projects converted using GX Works2, conversion may not be performed according to the state of the project. If there is an error in the program, operation will be canceled.
- To read projects of GX Works2 using GX Works3, delete the security (user Management, data security setting) of GX Works2 beforehand and then read the projects. If the security is set to the GX Works2 project, read out will be canceled.
- To read projects of GX Works2 using GX Works3, administrator rights are required.

Operating procedure

1. Start up GX Works3.
 2. Open the project of FX3U/FX3UC.
- Select [Project] ⇒ [Open Other Format File] ⇒ [GX Works2 Format] ⇒ [Open Project] ⇒ Project (***.gxw).

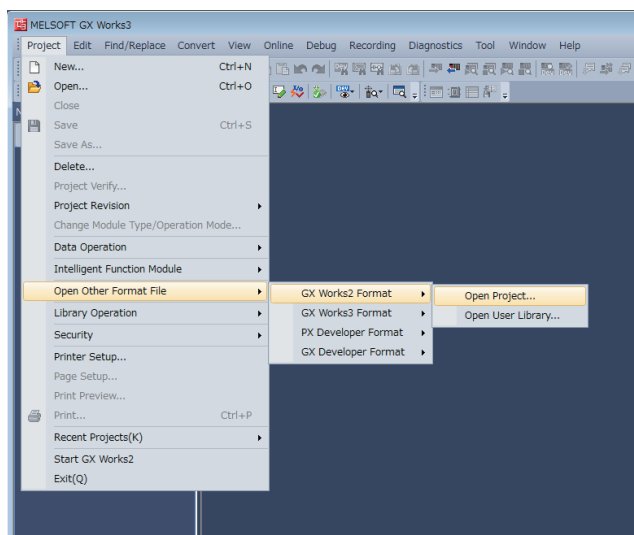

A

3. The following display is shown.

A selection screen of the following new module type and conversion method is shown.

Select the new module type and conversion method, and press the [Execute] button.

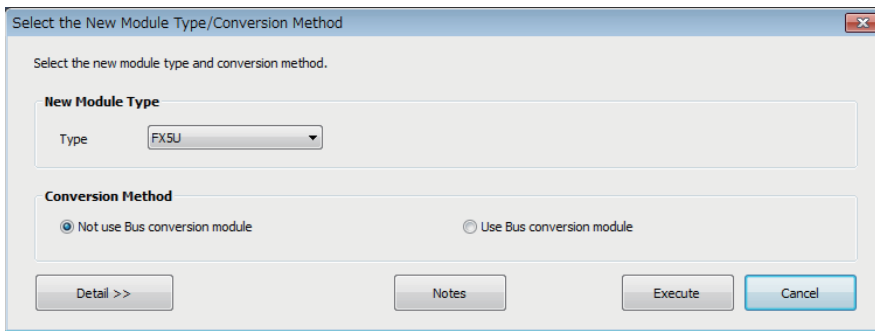

Point

- The display contents may vary depending on the version of the software.
- Precautions for the converted project are displayed. Please read carefully through the contents before use.

4. When conversion is completed, the following message is shown.

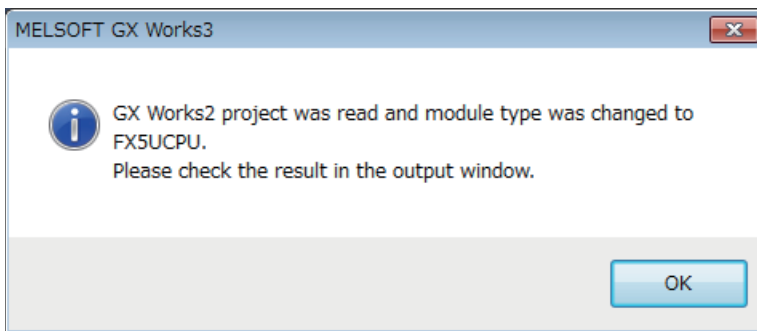

5. Check the contents of the model change result in the "Output window".

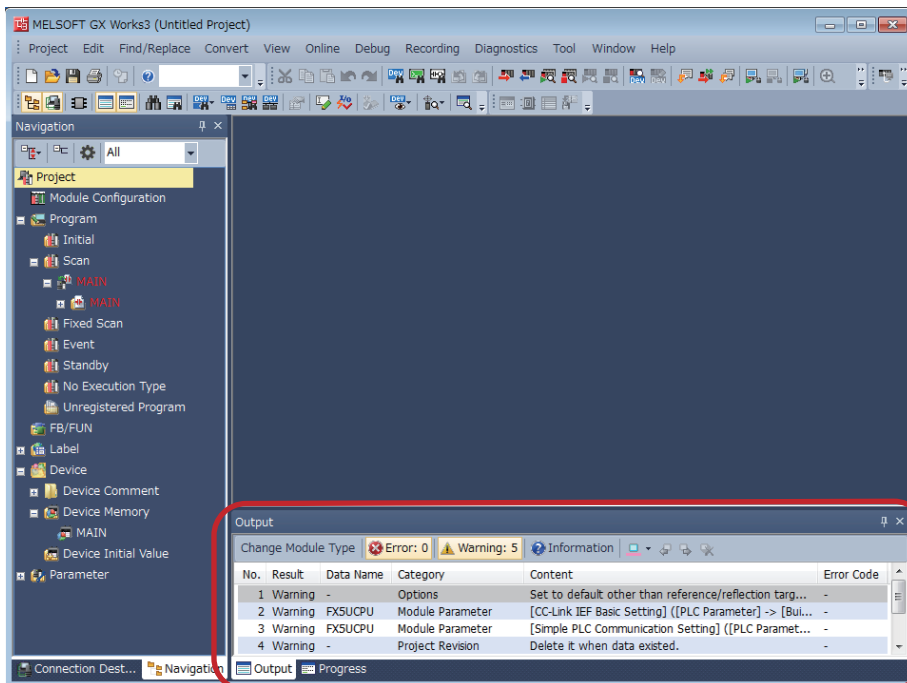

Precautions

When projects are converted, the program instructions and devices may be changed. Check the contents of the project. Parameters other than the network parameter of CC-Link*1 will be deleted. Set the parameters if necessary.

*1 For the network parameter of CC-Link, refer to  Page 120 Precautions when Replacing the Parameters.

6. Set the model name of the CPU for the system parameter.

 [System Parameter] ⇒ [I/O Assignment Setting] ⇒ Model Name

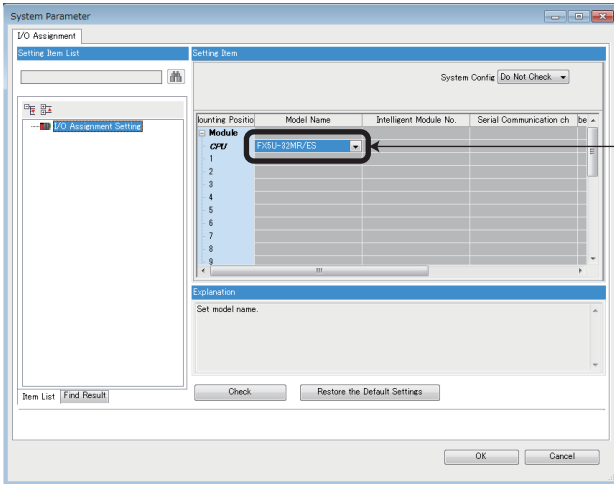

7. Perform conversion.

 [Convert] ⇒ [Rebuild All]

Precautions when Converting the Projects

The number of simultaneously activated steps varies between FX3U/FX3UC and FX5U/FX5UC.

Item	FX3U/FX3UC	FX5U/FX5UC
Number of simultaneously activated steps	<ul style="list-style-type: none"> • Up to 512 steps in 1 block • Up to 4096 steps in the whole system 	<ul style="list-style-type: none"> • Up to 128 steps in 1 block*¹ • Up to 128 steps in the whole system*²

*1 When the number of steps exceeds 128, a stop error (31B3H) will occur.

*2 When the number of steps exceeds 128, a stop error (31B4H) will occur.

Precautions when Replacing the Parameters

- When converting FX3U/FX3UC projects to FX5U/FX5UC projects, the setting data of the parameters (PC parameters and network parameters) and special modules (intelligent function modules) will be deleted. Therefore, it is necessary to set the data with GX Works3 again. Also, GX Works3 does not support the following parameters of the FX3U/FX3UC, so it is necessary to set these parameters with GX Works3 again.

- Network parameters (CC-Link)

- Intelligent function module parameter (AnyWireASLINK)

- The "SFC Setting" of "CPU Parameter" of GX Works3 is shown below. Change the parameters if necessary. For the parameter details, refer to the following.

 MELSEC iQ-F FX5 Programming Manual (Program Design)

Item	Value after replacement	Setting range
SFC Program Setting	Use	<ul style="list-style-type: none"> • Not to use (default) • Use
SFC Program Start Mode* ¹	Initial Start	<ul style="list-style-type: none"> • Initial Start (default) • Resume Start
Start Conditions	Do not auto-start block 0	<ul style="list-style-type: none"> • Auto-start block 0 (default) • Do not auto-start block 0
FX3 Compatible Transition Operation Mode	Enable	<ul style="list-style-type: none"> • Disable (default) • Enable

*1 If there is any step to be held in an active state, change the mode to "Resume Start". If the program is resumed, the active state at the previous stop (when SM321 is turned on and off, or the CPU module power is turned off and on or reset) can be held. For "Resume Start", the optional battery is required.

Precautions when Replacing the Program

- When MELSEC iQ-F uses the SFC program, a step relay (S) cannot be specified in any instruction other than the SFC control instructions. The SFC control instructions cannot be used in an interrupt program. After replacement, reexamine the program. For the details of the SFC control instructions, refer to  MELSEC iQ-F FX5 Programming Manual (Program Design).
- GX Works3 cannot make setting only with output without describing contacts in Zoom. Therefore, "LD SM400" is added to a circuit block without contacts.
- The step relay (S) of FX3U/FX3UC is replaced with a step relay with block specification (BL□\S□) on FX5U/FX5UC. The device comment is registered as the device comment of the step relay with block specification (BL□\S□) after replacement.
- When an FX3U/FX3UC project is converted into an FX5U/FX5UC project, the step relays (S) will be automatically reallocated. Therefore, when the step relays (S) of FX3U/FX3UC are used in an instruction intended for index modification, digit specification and multiple devices, reexamine the instruction after replacement.
- A step relay (S) not assigned to any step is replaced with "SM4095".
- A step relay (S) used for digit specification is replaced with "SD4095".

- When a ladder block is contained in an FX3U/FX3UC project, an initial execution type program is automatically added. The initial execution type program is created to start the SFC block that takes over the content of the ladder block.

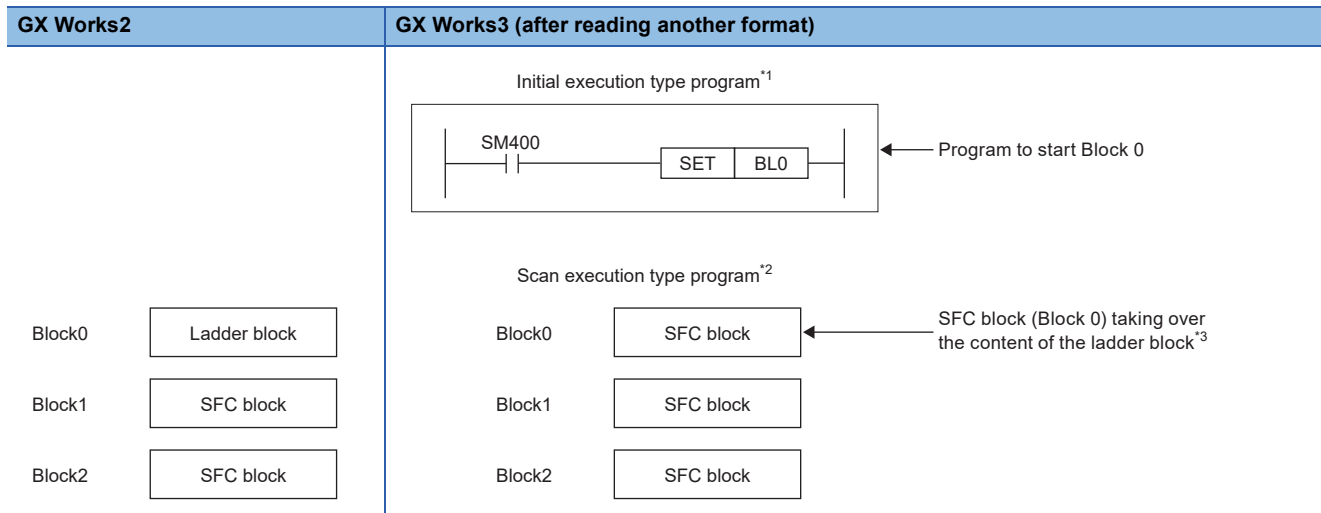

*1 The program is executed only once when the CPU module is switched from STOP/PAUSE to RUN.

*2 The program is executed only once per scan after the initial execution type program is executed.

*3 When "LD M8002" is used in the ladder block in an FX3U/FX3UC project, change "LDSM8002" to "LDP SM8003" as shown below after replacing with GX Works3.



- After replacement with GX Works3, the ladder block will be replaced with an initial step + disabled transition + a jump.

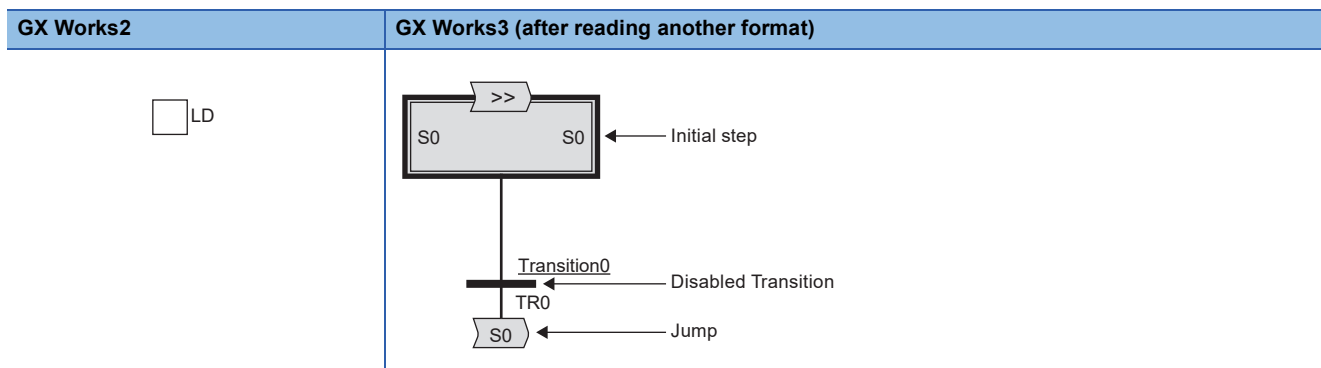

- After replacement with GX Works3, a jump to the initial steps (S0 to S9) of other blocks will be replaced with a block start step (without end check) [BS] + unconditional transition + an end step. The block start step will be added as the maximum step No. in own block + 1.

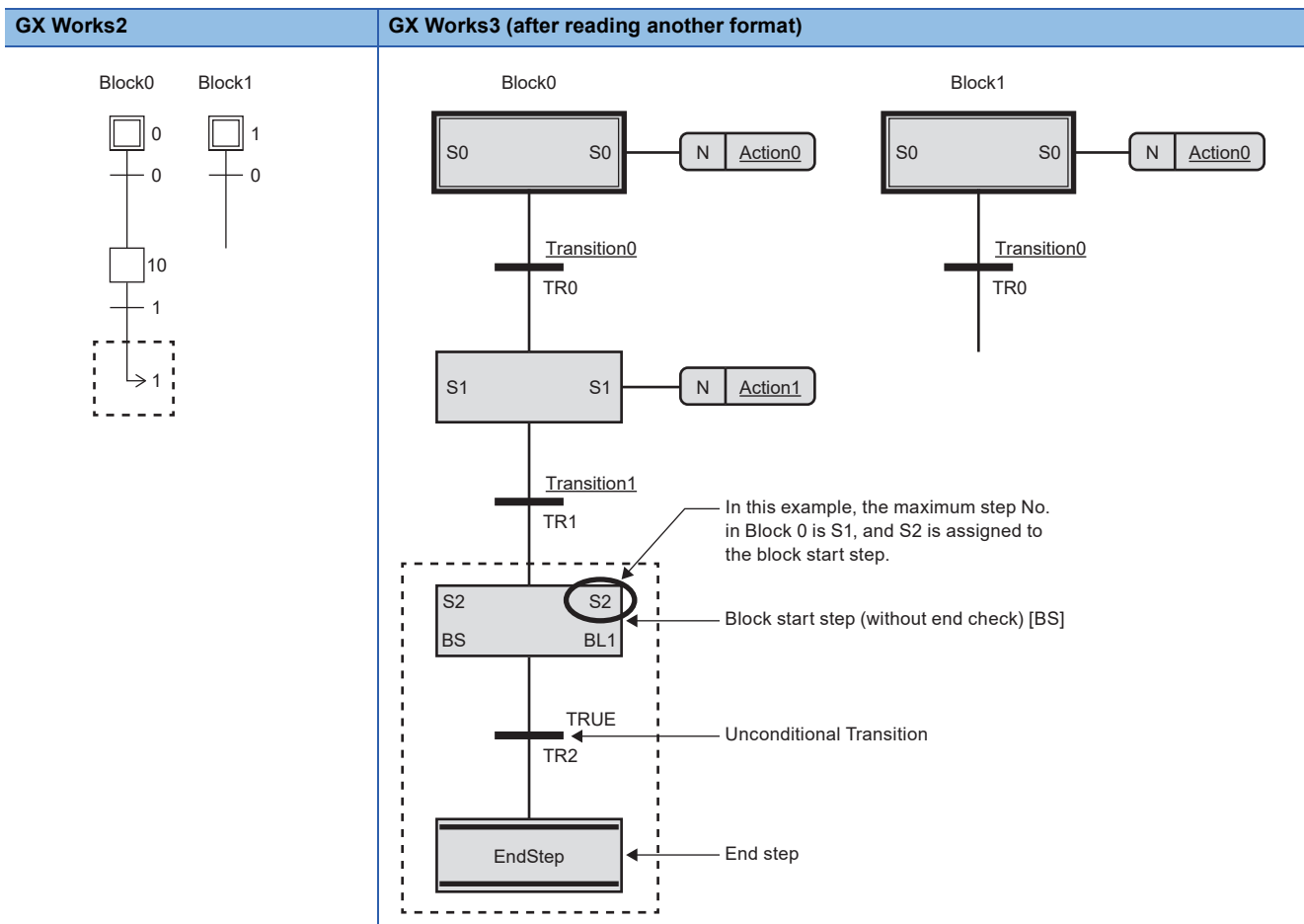

- A reset jump containing a self-reset will be replaced with an end step after replacement with GX Works3. When the reset jump used in an FX3U/FX3UC project is not a self-reset, reexamine the program.

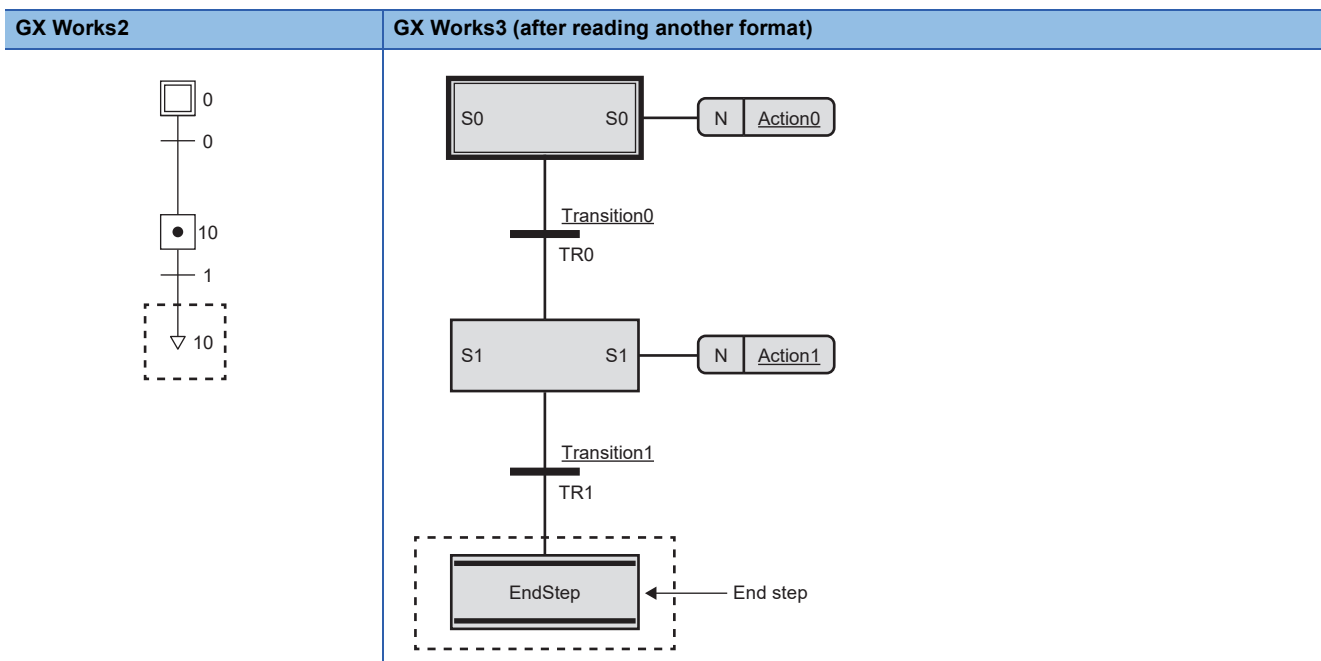

- An SFC block containing the following will be deleted after replacement with GX Works3. Modify the program if necessary.
 - Jump to a non-existent step
 - Jump to a step other than the initial steps of other blocks

MEMO

A

INDEX

A

Auxiliary relay 106,113

C

Character string constant 109
Counter 107,113

D

Data register 108,114
Decimal constant 109,114

E

Extension file register 108
Extension register 108

H

Hexadecimal constant 109,114
High-speed counter 108,114

I

Index register 108,114
Input hardware filter 24,39,54,68,82
Input relay 106,113
Input signal current 24,39,54,68,82
Interrupt pointer 109,114

M

Module access device 109

O

Output relay 106,113

P

Pointer 108,114

R

Real constant 109,114

S

State 106,113

T

Timer 107,113

MEMO

REVISIONS

Revision date	Revision	Description
December 2015	A	First edition
May 2016	B	<ul style="list-style-type: none"> ■Added models FX5U-32MR/DS, FX5U-32MT/DS, FX5U-32MT/DSS, FX5U-64MR/DS, FX5U-64MT/DS, FX5U-64MT/DSS, FX5U-80MR/DS, FX5U-80MT/DS, FX5U-80MT/DSS, FX5-32ER/DS, FX5-32ET/DS, FX5-32ET/DSS, FX5-CNV-IF, FX5-30EC, FX5-65EC, and FX5-CNV-BC ■Added and revised parts RELEVANT MANUALS, TERMS, Section 2.3, 3.3, 4.1, and 4.2
October 2016	C	<ul style="list-style-type: none"> ■Added models FX5-4AD-PT-ADP, FX5-4AD-TC-ADP, FX5-16ER/ES, FX5-16ET/ES, and FX5-16ET/ESS ■Added and revised parts RELEVANT MANUALS, TERMS, Section 2.3, 3.3, and 4.2
April 2017	D	<ul style="list-style-type: none"> ■Added models FX5-8AD, FX5-4LC, FX5-20PG-P, FX5-CCL-MS ■Added and revised parts SAFETY PRECAUTIONS, RELEVANT MANUALS, TERMS, Section 2.3, 3.3, 4.2
October 2017	E	<ul style="list-style-type: none"> ■Added models FX5-4AD, FX5-4DA, FX5-C32EX/DS-TS ■Added and revised parts RELEVANT MANUALS, TERMS, Section 2.3, 3.3, 4.1, 4.2, 4.3
October 2018	F	<ul style="list-style-type: none"> ■Added models FX5-20PG-D, FX5-DP-M ■Added and revised parts RELEVANT MANUALS, TERMS, Sections 2.3, 3.3
January 2019	G	<ul style="list-style-type: none"> ■Added models FX5UC-32MR/DS-TS, FX5-C16EYR/D-TS ■Added and revised parts SAFETY PRECAUTIONS, TERMS, Sections 3.3
October 2019	H	<ul style="list-style-type: none"> ■Added models FX5UJ CPU module ■Added and revised parts RELEVANT MANUALS, TERMS, Chapter 1, 2, 3, 4, 5, APPENDIX
May 2020	J	<ul style="list-style-type: none"> ■Added and revised parts RELEVANT MANUALS, TERMS, Sections 1.1, 2.4, 3.4, 4.4, 5.4, TRADEMARKS
October 2020	K	<ul style="list-style-type: none"> ■Added and revised parts RELEVANT MANUALS, Sections 2.4, 3.4, 4.4, 5.4, APPENDIX 1, 3, 5
April 2021	L	<ul style="list-style-type: none"> ■Added models FX5-4A-ADP ■Added and revised parts SAFETY PRECAUTIONS, RELEVANT MANUALS, TERMS, Section 2.3, 3.3, 4.3, 5.3
June 2021	M	<ul style="list-style-type: none"> ■Added or modified parts SAFETY PRECAUTIONS, WARRANTY
October 2022	N	<ul style="list-style-type: none"> ■Added or modified parts RELEVANT MANUALS
February 2023	P	<ul style="list-style-type: none"> ■Added model FX5S CPU module ■Added or modified parts Chapter 1, 2, 3, 4, 5, 6, APPENDIX

Japanese manual number: JY997D66101P

This manual confers no industrial property rights of any other kind, nor does it confer any patent licenses. Mitsubishi Electric Corporation cannot be held responsible for any problems involving industrial property rights which may occur as a result of using the contents noted in this manual.

©2015 MITSUBISHI ELECTRIC CORPORATION

WARRANTY

Please confirm the following product warranty details before using this product.

1. Gratis Warranty Term and Gratis Warranty Range

If any faults or defects (hereinafter "Failure") found to be the responsibility of Mitsubishi occurs during use of the product within the gratis warranty term, the product shall be repaired at no cost via the sales representative or Mitsubishi Service Company. However, if repairs are required onsite at domestic or overseas location, expenses to send an engineer will be solely at the customer's discretion. Mitsubishi shall not be held responsible for any re-commissioning, maintenance, or testing on-site that involves replacement of the failed module.

[Gratis Warranty Term]

The gratis warranty term of the product shall be for one year after the date of purchase or delivery to a designated place. Note that after manufacture and shipment from Mitsubishi, the maximum distribution period shall be six (6) months, and the longest gratis warranty term after manufacturing shall be eighteen (18) months. The gratis warranty term of repair parts shall not exceed the gratis warranty term before repairs.

[Gratis Warranty Range]

- (1) The range shall be limited to normal use within the usage state, usage methods and usage environment, etc., which follow the conditions and precautions, etc., given in the instruction manual, user's manual and caution labels on the product.
- (2) Even within the gratis warranty term, repairs shall be charged for in the following cases.
 1. Failure occurring from inappropriate storage or handling, carelessness or negligence by the user. Failure caused by the user's hardware or software design.
 2. Failure caused by unapproved modifications, etc., to the product by the user.
 3. When the Mitsubishi product is assembled into a user's device, Failure that could have been avoided if functions or structures, judged as necessary in the legal safety measures the user's device is subject to or as necessary by industry standards, had been provided.
 4. Failure that could have been avoided if consumable parts (battery, backlight, fuse, etc.) designated in the instruction manual had been correctly serviced or replaced.
 5. Relay failure or output contact failure caused by usage beyond the specified life of contact (cycles).
 6. Failure caused by external irresistible forces such as fires or abnormal voltages, and failure caused by force majeure such as earthquakes, lightning, wind and water damage.
 7. Failure caused by reasons unpredictable by scientific technology standards at time of shipment from Mitsubishi.
 8. Any other failure found not to be the responsibility of Mitsubishi or that admitted not to be so by the user.

2. Onerous repair term after discontinuation of production

- (1) Mitsubishi shall accept onerous product repairs for seven (7) years after production of the product is discontinued.
Discontinuation of production shall be notified with Mitsubishi Technical Bulletins, etc.
- (2) Product supply (including repair parts) is not available after production is discontinued.

3. Overseas service

Overseas, repairs shall be accepted by Mitsubishi's local overseas FA Center. Note that the repair conditions at each FA Center may differ.

4. Exclusion of loss in opportunity and secondary loss from warranty liability

Regardless of the gratis warranty term, Mitsubishi shall not be liable for compensation to:

- (1) Damages caused by any cause found not to be the responsibility of Mitsubishi.
- (2) Loss in opportunity, lost profits incurred to the user by Failures of Mitsubishi products.
- (3) Special damages and secondary damages whether foreseeable or not, compensation for accidents, and compensation for damages to products other than Mitsubishi products.
- (4) Replacement by the user, maintenance of on-site equipment, start-up test run and other tasks.

5. Changes in product specifications

The specifications given in the catalogs, manuals or technical documents are subject to change without prior notice.

6. Product application

- (1) In using the Mitsubishi MELSEC programmable controller, the usage conditions shall be that the application will not lead to a major accident even if any problem or fault should occur in the programmable controller device, and that backup and fail-safe functions are systematically provided outside of the device for any problem or fault.
- (2) The Mitsubishi programmable controller has been designed and manufactured for applications in general industries, etc. Thus, applications in which the public could be affected such as in nuclear power plants and other power plants operated by respective power companies, and applications in which a special quality assurance system is required, such as for railway companies or public service purposes shall be excluded from the programmable controller applications.
In addition, applications in which human life or property that could be greatly affected, such as in aircraft, medical applications, incineration and fuel devices, manned transportation, equipment for recreation and amusement, and safety devices, shall also be excluded from the programmable controller range of applications. However, in certain cases, some applications may be possible, providing the user consults their local Mitsubishi representative outlining the special requirements of the project, and providing that all parties concerned agree to the special circumstances, solely at the user's discretion.
- (3) Mitsubishi shall have no responsibility or liability for any problems involving programmable controller trouble and system trouble caused by DoS attacks, unauthorized access, computer viruses, and other cyberattacks.

TRADEMARKS

Anywire and AnyWireASLINK are either registered trademarks or trademarks of Anywire Corporation.

Phillips is a registered trademark of Phillips Screw Company.

The company names, system names and product names mentioned in this manual are either registered trademarks or trademarks of their respective companies.

In some cases, trademark symbols such as [™] or [®] are not specified in this manual.

Manual number: JY997D66201P

MITSUBISHI ELECTRIC CORPORATION

HEAD OFFICE: TOKYO BLDG., 2-7-3, MARUNOUCHI, CHIYODA-KU, TOKYO 100-8310, JAPAN
NAGOYA WORKS: 1-14, YADA-MINAMI 5-CHOME, HIGASHI-KU, NAGOYA 461-8670, JAPAN

When exported from Japan, this manual does not require application to the
Ministry of Economy, Trade and Industry for service transaction permission.

Specifications subject to change without notice.